

DRAINS, BATH ACCESSORIES & FINISHED PLUMBING

Catalogue | Dt. 1.10.2017

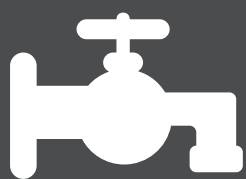

Classical Taps

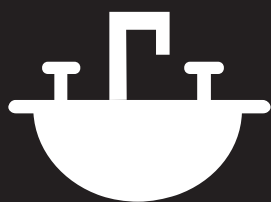

Wash Basin Accessories

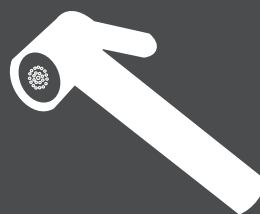

Health Faucet



Floor Drain



Tooth Brush Holder

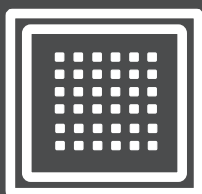

Roof Drain



Towel Ring



Rain Shower

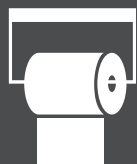

Toilet Paper Holder



Finished Plumbing
Elbow & Tee



Hex (Double) Nipple

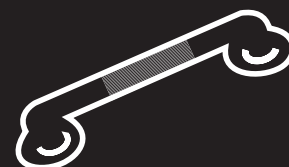

Grab Bar

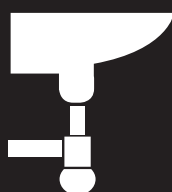

Bottle & P Trap



P.T.F.E. Tape



Fountain



Connection Hose (Pipe)

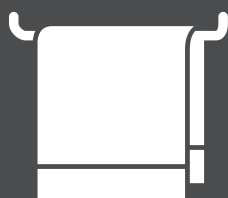

Towel Rail



Angle Cock



Shower



Linear Channel Drain

INDEX

	Pages No.
Angel Cock	54, 55, 56
Bath Accessories	
(i) Angel	30
(ii) Bear	28
(iii) Classic	11
(iv) Curves	14,15
(v) Diva	29
(vi) Edge	13
(vii) Escada	12
(viii) Geometrical	20,21
(vi) H2O	23, 24, 25
(ix) Ocular	10
(x) Pawn	22
(xi) Pebbles	16
(xii) Rectangular	17,18
(xiii) Square	9
Gold Accessories	
(i) H2O Gold	26, 27
(ii) Rectangular Gold	19
Bath Accessories Stand	31
Bath Tub or Chair	1
Bathtub Overflow Set	36
Body Jet	46
Bottle Trap (P-Trap, S-Trap) & Waste Pipe	37, 38, 33
Connections & SS Braided Pipe	31, 32
Drain & Cockroach Traps	
(i) Channel Drain (Long Drain)	84
(ii) Cockroach Traps	88
(iii) Corner Drains	77
(iv) Tile/Marble Drains	76, 83
Fountains	91,92
Garden Faucet	57
Grab Bar	
(i) CP Brass, SS 304 & ABS Grab Bar	6
(ii) Handicapped Grab Bar	6
(iii) Grab Bar Breakup parts	7, 8
Hand, Hair, Body Dryer & Dispenser	89, 90
Health Faucets & Hooks	41, 42
Jet Spray Set	40
Lotion Dispenser (Soap)	
Counter & Wall Mounted	3
Mirrors	
(i) Makeup/Shaving, Sticky & Traffic Mirror	4
Plumbing & Accessories	
(i) Ball Valve	67
(ii) Elbow	70
(iii) Extension	69
(iv) Flanges (Brass & SS)	63, 64
(v) Line Strainer	66
(vi) Pressure Reducing Valve	68
(vii) Running Nipple	65
(viii) Tee	71
Push Cock, Lab Cock & Urinal Cock	39, 58, 59 & 60
Rack Bolt	49, 50
Showers & Rain Showers	
(i) Ceiling Shower	44
(ii) Over Head Shower	45
(iii) Rain Shower	44, 46
(iv) Telephone Shower & Shower Tube	43
Spout	53
Tile Levelling (Clip, Spacer, Plier & Wedge)	61, 62
Towel Warmer (Electric Heated Rack)	31
Waste Coupling	34, 35
Urinal Accessories	
(i) Urinal Mat	40
(ii) Urinal Waste Coupling	39
(iii) Urinal Brackets	39

Feel Water at its best



Viking offers the most innovative range of aesthetically inspiring bath and kitchen fittings for the modern living. Established in 1966 in city of Jalandhar (INDIA), Viking has become a name to reckon when it comes to superior quality. Offering a complete range of Basic to Exclusive bathroom products and accessories for a broad spectrum of consumers; varying from an individual to developers and hospitality Industry, Viking is the preferred choice for contemporary living spaces.

Every Viking product possesses the inherent qualities of durability, resilience and practised expertise. Our proficiency lies in creating sophisticated bathroom ware that ranks highly in terms of design, innovation and contemporary appeal. We believe in crafting each product with an expertise over almost five decades of producing world-class bath and kitchen ware. Our products are supplied to over 255 cities across India, Nepal, Bhutan, Bangladesh, Sri Lanka and Seychelles.

With a unique combination of features and designs, Viking has been able to win the trust of many over the years, making it a brand of choice for anyone looking to facilitate the modern living space with innovative, high quality designer products.





Bath Tub Seat

Art No.	Colour
700	White

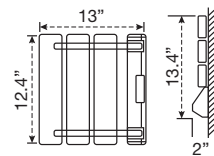

Best Seller

**Chair/Stool Foldable
(Wall Mounted)**

Art No.	Length	Breadth	Colour
701	325mm (13")	288mm (11.5")	White
701.02 (Spare Replacement Kit (Fastener Cover))			

makes your life relaxed ...

Wall Mounted **FOLDING** CHAIR (Rust Proof)



Weight Capacity upto **130 kgs.**



Easy Folding & Saves Space



Trendy



Comfortable

Most Suitable for:

- People with Knee Problem
- Old-age Person • Pregnant Lady
- Over Weight People



Useful In :

1. Bathrooms.
2. Try Rooms.
3. Waiting Room.
4. Shop Entrance (Changing Shoes)
5. Office/Shops with less Sitting space.
6. Hospitals.
7. Gymnasiums.
8. General Home use.



Toilet Seat Cover Dispenser

Art No.
717

718 (Paper only for Art no.717)
(Packing of 250 Pcs)



Toilet Paper Holder

Art No.	Finish
751	Ivory
752	White



Soap Holder Ocular

Art No.	Finish
1001	Polished CP



Soap Holder

Art No.	Finish
1005	Polished CP



**Soap Holder Sleek
- With Drain Base**

Art No.	Finish
1015	Polished CP



Flushable

Paper for Toilet Seat Cover
- Everyday travel pack
- No more unhygienic toilet seat.

Art No.
728

(Packing of 10 Pcs)



Soap Holder Tortoise

Art No.	Finish
1000	Polished CP



Soap Holder Square

Art No.	Finish
1003	Polished CP



Soap Holder Sleek

Art No.	Finish
1010	Polished CP



Soap Holder Vintage

Art No.	Material	Finish
1020	SS 304	CP



**Lotion Dispenser Triangle
(Countertop)**

Art No.	Capacity	Finish
1091	450ml	Polished CP



**Lotion Dispenser
(Countertop)**

Art No.	Capacity	Finish
1092	550ml	Polished CP



Pump for -1091 1092 1095

Art No.	Finish
1092.02	Polished CP



**Lotion Dispenser
(Countertop)**

Art No.	Capacity	Finish
1095	350ml	Polished CP



**Lotion Dispenser Ocular
(Wall Mounted)**

Art No.	Capacity	Finish
1115	500ml	Polished CP



**Lotion Dispenser Vintage Big
(Wall Mounted)**

Art No.	Capacity	Colour
1120	900ml	White



Best Seller

**Lotion Dispenser Small
(Wall Mounted)**

Art No.	Capacity	Finish
1125	200ml	Transparent
1127	500ml	Transparent



**Lotion Dispenser Twin
(Wall Mounted)**

Art No.	Capacity	Finish
1130	200+200ml	Transparent



**Lotion Dispenser Vista
(Wall Mounted)**

Art No.	Capacity	Material	Finish
1135	600ml	SS 304	Brushed
1137	1000ml	SS 304	Brushed



**Lotion Dispenser Axis
(Under Table)**

Art No.	Capacity	Material	Finish
1138	250ml	SS 304	Polished CP



Makeup & Shaving Mirror
(3x Magnifying)

Art No.	Dia	Finish
1150	150mm(6")	Polished CP
1152	200mm(8")	Polished CP



Makeup & Shaving Mirror LED Square

Art No.	Length	Breadth	Finish
1155	200mm(8")	200mm(8")	Polished CP

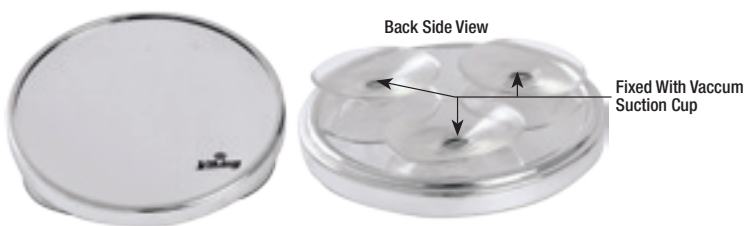

Makeup & Shaving Mirror
- No Installation Required.

Art No.	Dia	Finish
54909	125mm(5")	Polished CP



Traffic Mirror Convex

Art No.	Dia	Colour
88900	450mm (18")	Orange
88910	600mm (24")	Orange
88918	800mm (32")	Orange

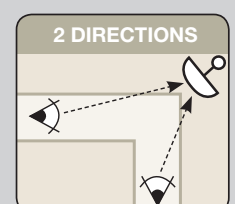

Cover Blind Area (Spot)



Toilet Brush & Holder
(Wall Mounted)

Art No.	Finish
1171	Polished CP
1172 (Brush Only)	Polished CP



Cloth Liner

Art No.	Length	Material	Finish
1226	2.5 mtr(98")	SS 304	Polished



- Do not waste your time to find bottle opener.
- Fixed it and never find again



Bottle Opener

Art No.	Material	Finish
1231	SS 304	Polished CP



Bottle Opener

Art No.	Material	Finish
1235	SS 304	Brushed



Wall Hook Fancy

Art No.	Finish
1291	CP
1292	Antique Brass

Everyone! People of all ages and abilities can benefit from using grab bars. If elderly people are having any difficulty with mobility or balance, grab bars are a must! It will relax your life on the Toilet Seat/Bathroom.



👍 Benefits of Grab Bars

- Helps to pull or push themselves into a different position, such as from sitting to standing, or to assist with scooting from one surface to another.
- Helps to stabilize themselves while seated on a toilet or a shower seat.
- Helps to stabilize themselves while stepping up or down a step.
- Helps to mitigate slips & fall .



Grab Bar

Art No.	Length	Material	Finish
1159	225mm(9")	Brass	Polished CP
1160	300mm(12")	Brass	Polished CP
1161	375mm(15")	Brass	Polished CP
1162	450mm(18")	Brass	Polished CP
1163	600mm(24")	Brass	Polished CP



Grab Bar

- Weight Capacity upto 175 Kg.
- SS 304 Material for Outdoor Installation.
- 32mm Dia pipe brushed finish for Better Grip
- Custom length for quantities more than 25 Pcs.

Art No.	Length	Material	Breadth	Finish
56420	225mm (9")	SS 304	32mm	Brushed
56422	300mm (12")	SS 304	32mm	Brushed
56426	450mm (18")	SS 304	32mm	Brushed
56428	600mm (24")	SS 304	32mm	Brushed
56430	900mm (36")	SS 304	32mm	Brushed
56432	1200mm (48")	SS 304	32mm	Brushed



Grab Bar ABS

Art No.	Length	Material	Breadth	Finish
56600	300mm(12")	ABS	35mm	White
56602	450mm(18")	ABS	35mm	White
56604	600mm(24")	ABS	35mm	White
56606	900mm(36")	ABS	35mm	White

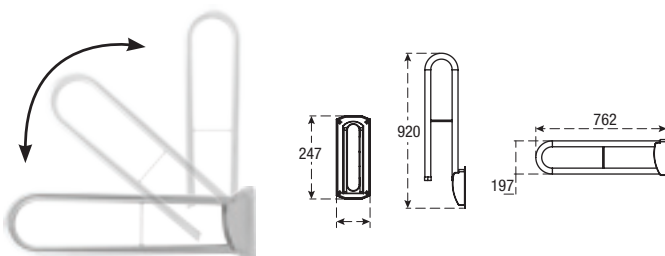

Grab Bar For Handicapped Persons

Art No.	Material	Finish
56630	SS 304	Brushed

56630.01.03 (Screw set for 56630 & 56631)

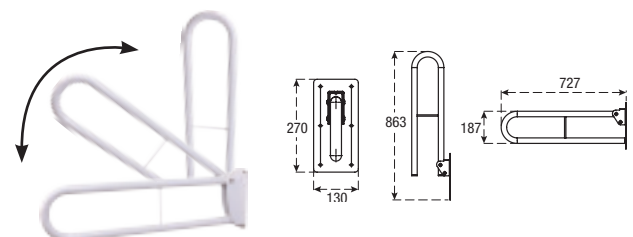

Grab Bar For Handicapped Persons

Art No.	Material	Colour
56631	MS (Mild Steel)	White



• Give your loved ones for their freedom with Modular Grab Bar. • No need to Support of helpers/Nurse.



Pipe for Grab Bar

Art No.	Length	Dia	Material	Colour
56740	170mm	35mm	ABS	White
56744	225mm (9")	35mm	ABS	White
56747	300mm(12")	35mm	ABS	White
56752	375mm(15")	35mm	ABS	White
56755	530mm	35mm	ABS	White
56757	835mm	35mm	ABS	White



End Elbow

Art No.	Material	Colour
56762	ABS	White

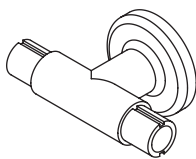

T Connector

Art No.	Material	Colour
56765	ABS	White



Elbow Connector 135°

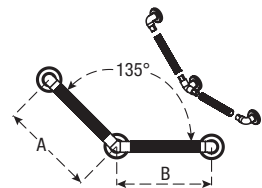

Grab Bar 135°

Art No.	Length	Breadth	Material	Colour
56768				White
56650 Grab Bar -135°	300mm(12")	300mm(12")	ABS	White
56652 Grab Bar -135°	450mm(18")	450mm(18")	ABS	White

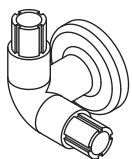

Elbow Connector 90°

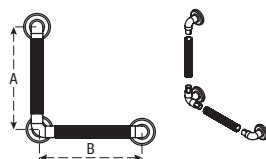

Grab Bar 90°

Art No.	Length	Height	Material	Colour
56772				White
56695 Grab Bar -90°	300mm(12")	300mm(12")	ABS	White
56697 Grab Bar -90°	450mm(18")	450mm(18")	ABS	White

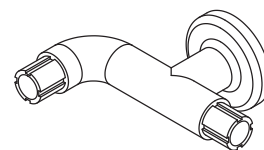

2 Wall Elbow Connector 90°-with post

Art No.	Material	Colour
56775	ABS	White

Make Grab Bar as per your convenience.

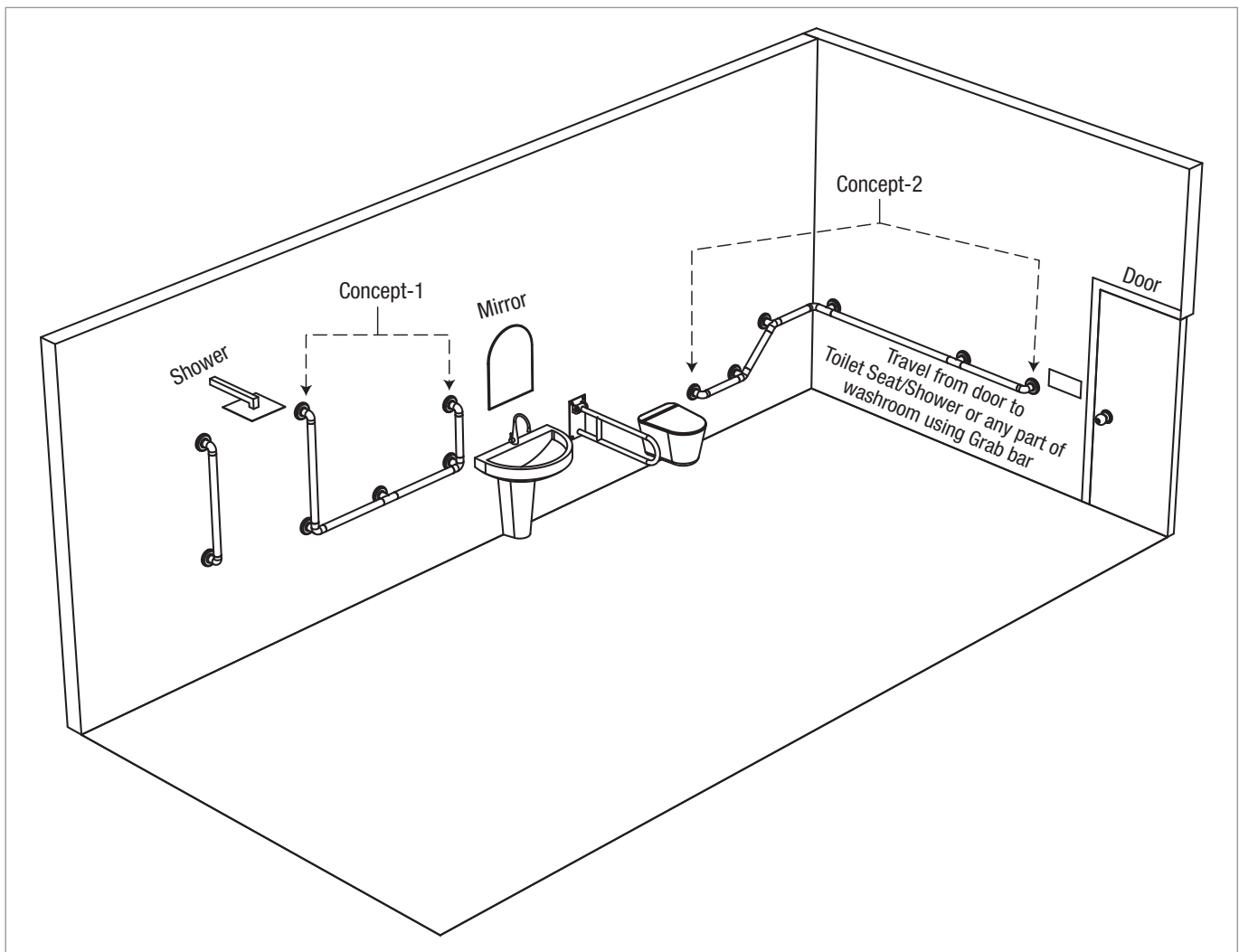

Breakup parts used in Concept 1 & 2

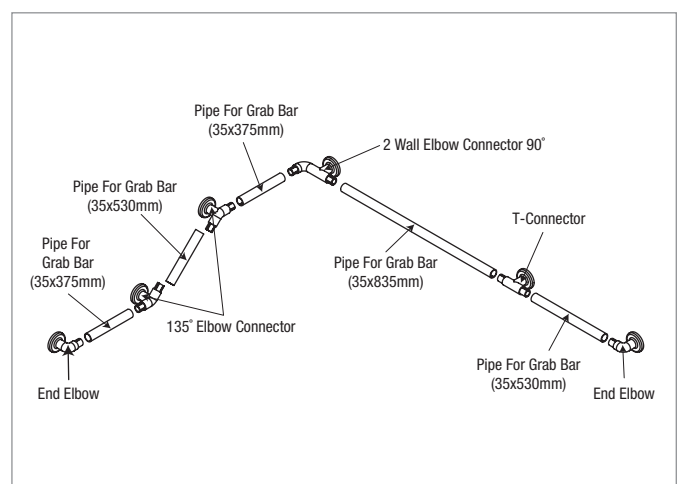
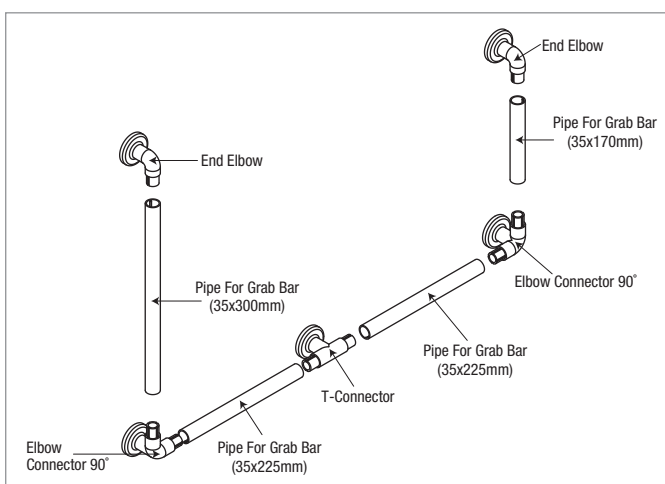

Art No.	Name	Quantity
56762	End Elbow	2
56747	Pipe for Grab Bar	1
56772	Elbow Connector 90°	2
56744	Pipe for Grab Bar	2
56765	T-Connector	1
56740	Pipe for Grab Bar	1

Art No.	Name	Quantity
56762	End Elbow	2
56752	Pipe for Grab Bar	2
56768	Elbow Connector 90°	2
56775	Pipe for Grab Bar	1
56765	T-Connector	1
56757	Pipe for Grab Bar	1
56755	2 Wall Elbow Connector 90°	2

SQUARE BATH ACCESSORIES

Set of 5 Pcs (1330,1335, 1340, 1345, 1350)



Soap Dish Square-Sleek

Art No.	Finish
1330	Polished CP



Towel Ring Square

Art No.	Finish
1335	Polished CP



Tumbler Holder Square

Art No.	Finish
1340	Polished CP



Towel Rail Square

Art No.	Length	Finish
1343	450mm(18")	Polished CP
1345	600mm(24")	Polished CP



Robe Hook Square

Art No.	Finish
1350	Polished CP



Toilet Paper Holder Square

Art No.	Finish
1355	Polished CP



Towel Rack with Rail & Hooks Square

Art No.	Length	Finish
1360	600mm(24")	Polished CP



Double Towel Rail Square

Art No.	Length	Finish
1370	600mm(24")	Polished CP



Double Glass Shelf

Art No.	Length	Material	Finish
1375	450mm(18")	Glass	Frosted
1375.50 (Left Double shelf Holder Assembly)		Brass	Polished CP
1375.51 (Right Double shelf Holder Assembly)		Brass	Polished CP



Soap Dish Ocular

Art No.	Finish
1430	Polished CP



Tumbler Holder with Tumbler Ocular

Art No.	Finish
1440	Polished CP



Robe Hook Ocular

Art No.	Finish
1450	Polished CP

OCULAR BATH ACCESSORIES

Set of 5 Pcs (1430,1435, 1440, 1445, 1450)

Art No.	Finish
1401	Polished CP



Towel Ring Ocular

Art No.	Finish
1435	Polished CP



Towel Rail Ocular

Art No.	Length	Finish
1443	450mm(18")	Polished CP
1445	600mm(24")	Polished CP



Toilet Paper Holder Ocular

Art No.	Finish
1455	Polished CP

CLASSIC BATH ACCESSORIES

Set of 5 Pcs (1530, 1535, 1540, 1545, 1550)



Soap Dish Classic

Art No.	Finish
1530	Polished CP



Towel Ring Classic

Art No.	Finish
1535	Polished CP



Tumbler Holder with Tumbler Classic

Art No.	Finish
1540	Polished CP



Towel Rail Classic

Art No.	Length	Finish
1543	450mm(18")	Polished CP
1545	600mm(24")	Polished CP



Robe Hook Classic

Art No.	Finish
1550	Polished CP



**Towel Rack Classic
(With Rail & Hooks)**

Art No.	Length	Finish
1560	600mm(24")	Polished CP

ESCADA BATH ACCESSORIES

Set of 5 Pcs (1601,1602, 1603, 1605, 1608)

Art No.	Finish
1600	Polished CP



Towel Ring Escada

Art No.	Finish
1602	Polished CP



Robe Hook Escada

Art No.	Finish
1605	Polished CP



Toilet Paper Holder Escada

Art No.	Finish
1612	Polished CP



Soap Dish Escada

Art No.	Finish
1601	Polished CP
1601.03 Wall Bracket for 1600 Escada Series	Zinc Plated
1601.05 Grub Screw for 1600 Escada Series	Steel



Tumbler Holder Escada

Art No.	Finish
1603	Polished CP



Towel Rail Escada

Art No.	Length	Finish
1607	600mm(24")	Polished CP
1608	450mm(18")	Polished CP

EDGE BATH ACCESSORIES

Set of 5 Pcs (1621,1622, 1623, 1625, 1627)



Soap Dish Edge

Art No.	Finish
1621	Polished CP



Toilet Paper Holder Edge

Art No.	Finish
1622 L	Polished CP



Tumbler Holder Edge

Art No.	Finish
1623	Polished CP



Robe Hook Edge

Art No.	Finish
1625	Polished CP



Toilet Paper Holder Edge

Art No.	Finish
1632	Polished CP

Art No.	Finish
1620	Polished CP



Towel Ring Edge-Round

Art No.	Finish
1622	Polished CP



Double Tumbler Holder Edge

Art No.	Finish
1623 D	Polished CP



Towel Rail Edge

Art No.	Length	Finish
1626	450mm(18")	Polished CP
1627	600mm(24")	Polished CP



Towel Rack Edge

Art No.	Finish
1635	Polished CP

CURVES BATH ACCESSORIES

Set of 5 Pcs (1661,1662, 1663, 1665, 1667)



Soap Dish Curves

Art No.	Material	Finish
1661	SS 304	Polished



Towel Ring Curves

Art No.	Material	Finish
1662	SS 304	Polished



Tumbler Holder Curves

Art No.	Material	Finish
1663	SS 304	Polished



Double Tumbler Holder Curves

Art No.	Material	Finish
1663 D	SS 304	Polished



Robe Hook Curves

Art No.	Material	Finish
1665	SS 304	Polished



Towel Rail Curves

Art No.	Length	Material	Finish
1667	600mm(24")	SS 304	Polished



Toilet Paper Holder Curves

Art No.	Material	Finish
1671	SS 304	Polished



Toilet Brush Holder Curves

Art No.	Material	Finish
1673	SS 304	Polished



Towel Rack Curves

Art No.	Length	Material	Finish
1675	600mm(24")	SS 304	Polished



Shelf Curves

Art No.	Length	Material	Finish
1678	450mm(18")	SS 304	Polished



Toilet Paper with Flap

Art No.	Material	Finish
38880	SS 304	Polished

PEBBLES BATH ACCESSORIES

Set of 5 Pcs (1681,1682, 1683, 1685, 1687)

Art No.
1680



Towel Ring Pebbles

Art No.	Material	Finish
1682	SS 304	Polished



Robe Hook Pebbles

Art No.	Material	Finish
1685	SS 304	Polished



Toilet Paper Holder Without Lid Pebbles

Art No.	Material	Finish
1691	SS 304	Polished
1691 G	SS 304	Gold PVD



Glass Shelf Pebbles

Art No.	Length	Material	Breadth	Finish
1698	600mm (24")	SS 304	120mm	Polished



Soap Dish Pebbles

Art No.	Material	Finish
1681	SS 304	Polished
1681.02 (Oval Soap Dish)	Glass	Frosted



Tooth Brush Holder Pebbles

Art No.	Material	Finish
1683	SS 304	Polished
1683.02 (Glass Tumbler)	Glass	Frosted



Towel Rail Pebbles

Art No.	Length	Material	Finish
1687	600mm(24")	SS 304	Polished



Toilet Brush & Holder Pebbles

Art No.	Material	Finish
1693	SS 304	Polished



Lotion Dispenser Pebbles

Art No.	Finish
1699	Polished CP

RECTANGULAR BATH ACCESSORIES

Set of 5 Pcs (1730,1734 (Flat), 1735 (Round), 1740, 1745, 1750)

Art No.	Finish
1701	Polished CP
1702	Polished CP



Soap Dish Rectangular

Art No.	Finish
1730	Polished CP
1730.05 (Bracket for Rectangle Series (Except Rack)	Brass
1730.12 (Grub Screw)	Steel



Towel Ring Rectangular - Flat

Art No.	Finish
1734	Polished CP



Towel Ring Rectangular

Art No.	Finish
1735	Polished CP
1735.50 (Spare Screw Dowel Set (2 Each)	Polished CP



Tumbler Holder with Tumbler Rectangular

Art No.	Finish
1740	Polished CP



Towel Rail Rectangular

Art No.	Length	Finish
1743	450mm(18")	Polished CP
1745	600mm(24")	Polished CP



Robe Hook Rectangular

Art No.	Finish
1750	Polished CP



Toilet Paper Holder Rectangular

Art No.	Finish
1755	Polished CP



Toilet Paper Holder Rectangular - With Cover

Art No.	Finish
1756	Polished CP



Towel Rack Rectangular

Art No.	Length	Height	Finish
1759	450mm(18")	85mm	Polished CP
1760	600mm(24")	85mm	Polished CP
1760.04 Wall Bracket for Towel Rack Rectangular			Brass

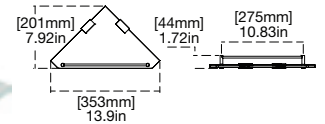

Corner Glass Shelf Rectangular

Art No.	Length	Breadth	Finish
1763	250mm(10")	250mm(10")	Frosted



Bracket Set for 5 to 8 mm Thick Shelf

Art No.	Length	Height	Finish
1767	42 mm	21mm	Polished CP



2 Level Glass Shelf Rectangular

Art No.	Length	Breadth	Height	Finish
1774	450mm(18")	8mm	150mm(6")	Frosted

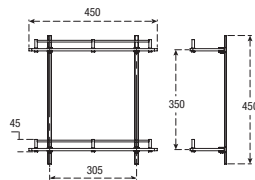

Double Glass Shelf Rectangular

Art No.	Length	Finish
1780	375mm (15")	Frosted

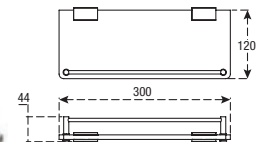

Glass Shelf With Rail Rectangular (Wall Brackets)

Art No.	Length	Breadth	Height	Finish
1785	300mm(12")	8mm	120mm	Frosted
1787	450mm(18")	8mm	120mm	Frosted
1789	600mm(24")	8mm	120mm	Frosted



Glass Shelf Without Rail Rectangular (Wall Brackets)

Art No.	Length	Breadth	Height	Finish
1791	450mm(18")	8mm	120mm	Frosted
1793	600mm (24")	8mm	120mm	Frosted



Glass Shelf With Rail Rectangular (Side Brackets)

Art No.	Length	Breadth	Height	Finish
1794	450mm(18")	8 mm	120mm	Frosted
1795	600mm(24")	8 mm	120mm	Frosted

RECTANGULAR BATH ACCESSORIES GOLD

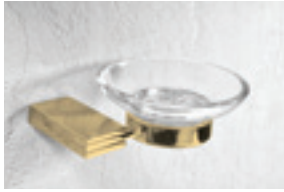

Soap Dish Rectangular

Art No.	Finish
1730 G	Gold PVD



Tumbler Holder Rectangular

Art No.	Finish
1740 G	Gold PVD



Robe Hook Rectangular

Art No.	Finish
1750 G	Gold PVD



**Toilet Paper Holder Rectangular
- With Cover**

Art No.	Finish
1756 G	Gold PVD



**Glass Shelf With Rail Rectangular
(Wall Brackets)**

Art No.	Length	Breadth	Height	Finish
1794 G	450mm(18")	8mm	120mm	Gold PVD
1795 G	600mm(24")	8mm	120mm	Gold PVD



Towel Ring Rectangular

Art No.	Finish
1735 G	Gold PVD

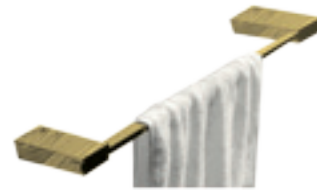

Towel Rail Rectangular

Art No.	Length	Finish
1743 G	450mm(18")	Gold PVD
1745 G	600mm(24")	Gold PVD



Toilet Paper Holder Rectangular

Art No.	Finish
1755 G	Gold PVD



Towel Rack Rectangular

Art No.	Length	Height	Finish
1760 G	600mm(24")	85mm	Gold PVD



**Glass Shelf With Rail Rectangular
(Side Brackets)**

Art No.	Length	Breadth	Height	Finish
1787 G	450mm(18")	8mm	120mm	Gold PVD
1789 G	600mm(24")	8mm	120mm	Gold PVD

GEOMETRICAL BATH ACCESSORIES

Set of 5 Pcs (1830,1835, 1840, 1845, 1850)

Art No.	Finish
1801	Polished CP



Towel Ring Geometrical

Art No.	Finish
1835	Polished CP



Towel Rail Geometrical

Art No.	Length	Finish
1843	450mm(18")	Polished CP
1845	600mm(24")	Polished CP



Toilet Paper Holder Geometrical

Art No.	Finish
1855	Polished CP



**Towel Rack Geometrical
- With Rail**

Art No.	Length	Finish
1860	600mm(24")	Polished CP



Soap Dish Geometrical

Art No.	Finish
1830	Polished CP



Tumbler Holder with Tumbler Geometrical

Art No.	Finish
1840	Polished CP



Robe Hook Geometrical

Art No.	Finish
1850	Polished CP



**Toilet Paper Holder Geometrical
- With Cover**

Art No.	Finish
1856	Polished CP



Corner Glass Shelf Geometrical

Art No.	Length	Breadth	Height	Finish
1863	250mm(10")	8 mm	250mm(10")	Frosted



Corner Glass Shelf Without Rail Geometrical

Art No.	Length	Breadth	Height	Finish
1865	250mm(10")	8 mm	250mm(10")	Frosted



2 Level-Glass Shelf Geometrical

Art No.	Length	Breadth	Height	Finish
1874	450mm(18")	8mm	150mm(6")	Frosted



**Glass Shelf With Rail Geometrical
(Wall Brackets)**

Art No.	Length	Breadth	Height	Finish
1885	300mm(12")	8mm	120mm	Frosted
1887	450mm(18")	8mm	120mm	Frosted
1889	600mm(24")	8mm	120mm	Frosted

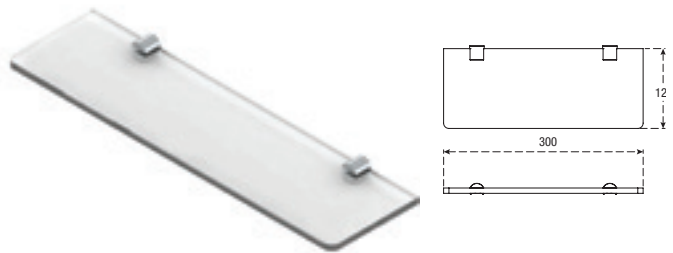

**Glass Shelf Without Rail Geometrical
(Wall Brackets)**

Art No.	Length	Breadth	Height	Finish
1890	300mm(12")	8mm	120mm	Frosted
1891	450mm(18")	8mm	120mm	Frosted
1892	600mm(24")	8mm	120mm	Frosted



**Glass Shelf With Rail Geometrical
(Side Brackets)**

Art No.	Length	Breadth	Height	Finish
1893	450mm(18")	8 mm	120mm	Frosted
1895	600mm(24")	8mm	120mm	Frosted

PAWN BATH ACCESSORIES

Set of 5 Pcs (1921, 1922, 1923, 1925, 1928)

Art No.	Finish
1920	Polished CP



Towel Ring - Round Pawn

Art No.	Finish
1922	Polished CP



Tumbler Holder Pawn

Art No.	Finish
1923	Polished CP



Towel Rail Pawn

Art No.	Length	Finish
1927	600mm(24")	Polished CP
1928	450mm(18")	Polished CP



Towel Rack Pawn

Art No.	Length	Finish
1935	600mm(24")	Polished CP



Soap Dish Pawn

Art No.	Finish
1921	Polished CP



Towel Ring-Flat Pawn

Art No.	Finish
1922 L	Polished CP



Robe Hook Pawn

Art No.	Finish
1925	Polished CP



Toilet Paper Holder Pawn

Art No.	Finish
1932	Polished CP



Glass Shelf Pawn

Art No.	Length	Finish
1937	450mm(18")	Frosted
1938	600mm(24")	Frosted

H₂O BATH ACCESSORIES

Set of 5 Pcs (1941, 1942, 1943, 1945, 1948)

This series is also available in 4 Colours on request.

(Pink, Blue, White, Black)

Art No.	Finish
1940	Polished CP



Towel Ring-Square H₂O

Art No.	Finish
1942	Polished CP



Towel Ring-Flat H₂O

Art No.	Finish
1942 F	Polished CP



Towel Ring-Round H₂O

Art No.	Finish
1944	Polished CP



Soap Dish H₂O

Art No.	Material	Finish
1941	Brass	Polished CP
1941 H (Soap Dish with Hole)	Brass	Polished CP
1941.02 (Wall Bracket for H ₂ O)	Brass	Brass
1941.05 (Glass Soap Dish without Hole)	Glass	Frosted
1941H.05 (Glass Soap Dish with Hole)	Glass	Frosted

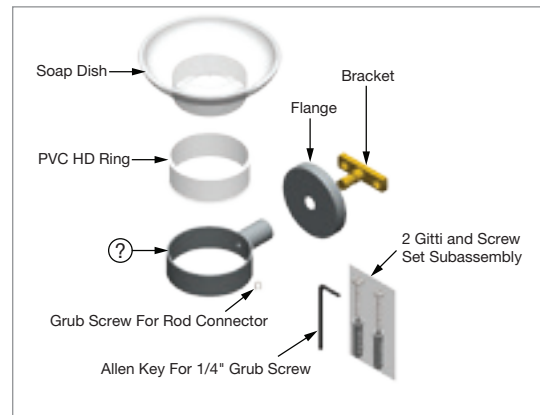

Breakup view of 1941 parts.



Tumbler Holder H₂O

Art No.	Finish
1943	Polished CP
1943.05 (Tumbler)	Frosted



Robe Hook H₂O

Art No.	Finish
1945	Polished CP



Towel Rail H₂O

Art No.	Length	Finish
1947	450mm(18")	Polished CP
1948	600mm (24")	Polished CP



Toilet Paper Holder H₂O

Art No.	Finish
1951	Polished CP



**Toilet Paper Holder H₂O
- With Flap**

Art No.	Finish
1952	Polished CP



Double Toilet Paper Holder H₂O

Art No.	Finish
1953	Polished CP



Toilet Paper Holder Vertical H₂O

Art No.	Finish
1954	Polished CP



Towel Rack H₂O

Art No.	Length	Finish
1955	600mm (24")	Polished CP
1956	450mm(18")	Polished CP

Coming Soon



Hair Dryer Holder H₂O

Art No.	Finish
1966	Polished CP

Towel Rack without Lower Rail With 3 Hooks H₂O

Art No.	Length	Finish
1957	450mm(18")	Polished CP
1958	600mm(24")	Polished CP



Coming Soon

Towel Holder Swivel Twin Type H₂O

Art No.	Finish
1968	Polished CP

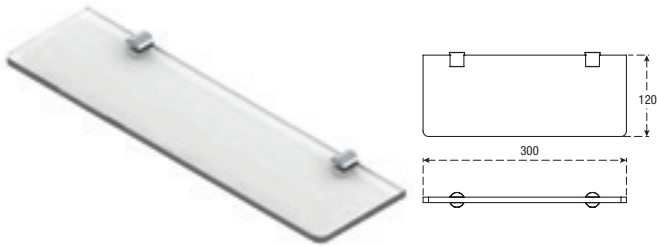

Toilet Brush Holder H₂O

Art No.	Finish
1969	Polished CP

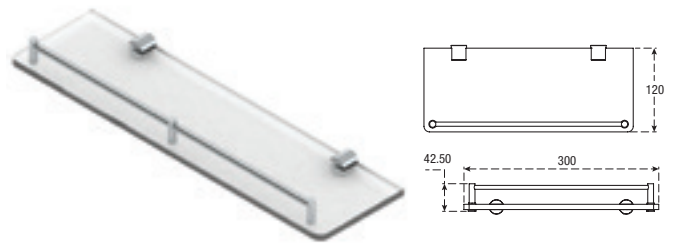

Glass Shelf Without Rail H₂O

Art No.	Length	Breadth	Height	Finish
1971	300mm(12")	8mm	120mm	Transparent
1972	450mm(18")	8mm	120mm	Transparent
1973	600mm(24")	8mm <td 120mm	Transparent	



Glass Shelf With Rail H₂O

Art No.	Length	Breadth	Height	Finish
1975	300mm(12")	8mm	120mm	Transparent
1976	450mm(18")	8mm	120mm	Transparent
1977	600mm(24")	8mm	120mm	Transparent



Glass Shelf With Tumbler H₂O

Art No.	Length	Breadth	Height	Finish
1979	450mm(18")	8mm	120mm	Transparent
1980	600mm(24")	8mm	120mm	Transparent



Corner Glass Shelf With Rail H₂O

Art No.	Length	Breadth	Height	Finish
1985	250mm(10")	8 mm	250mm(10")	Transparent



Corner Glass Shelf-Without Rail H₂O

Art No.	Length	Breadth	Height	Finish
1987	250mm(10")	8mm	250mm(10")	Transparent

Bracket for 5 to 8mm Shelf H₂O

Art No.	Length	Breadth	Finish
1999	22mm	22mm	Polished CP

H₂O BATH ACCESSORIES GOLD

Set of 5 Pcs (1941 G, 1942 G, 1943 G, 1945 G, 1948 G)

Art No.	Finish
1940 G	Polished CP



Towel Ring-Square H₂O

Art No.	Finish
1942 G	Gold PVD



Towel Ring-Round H₂O

Art No.	Finish
1944 G	Gold PVD



Towel Rail H₂O

Art No.	Length	Finish
1947 G	450mm(18")	Gold PVD
1948 G	600mm(24")	Gold PVD



Toilet Paper Holder H₂O
- With Flap

Art No.	Finish
1952 G	Gold PVD



Soap Dish H₂O

Art No.	Finish
1941 G	Gold PVD



Tumbler Holder H₂O

Art No.	Finish
1943 G	Gold PVD



Robe Hook H₂O

Art No.	Finish
1945 G	Gold PVD



Toilet Paper Holder H₂O

Art No.	Finish
1951 G	Gold PVD



Towel Rack H₂O

Art No.	Length	Finish
1955 G	600mm(24")	Gold PVD

Coming Soon



Toilet Brush Holder

Art No.	Finish
1969 G	Gold PVD



Glass Shelf Without Rail

Art No.	Length	Breadth	Height	Finish
1972 G	450mm(18")	8mm	120mm	Transparent
1973 G	600mm(24")	8mm	120mm	Transparent



Glass Shelf With Rail

Art No.	Length	Breadth	Height	Finish
1976 G	450mm(18")	8mm	120mm	Transparent
1977 G	600mm(24")	8mm	120mm	Transparent



Corner Glass Shelf With Rail

Art No.	Length	Breadth	Height	Finish
1985 G	250mm(10")	8 mm	250mm(10")	Transparent



Corner Glass Shelf - Without Rail

Art No.	Length	Breadth	Height	Finish
1987 G	250mm(10")	8mm	250mm(10")	Transparent



Bracket for 5 to 8 mm Shelf

Art No.	Length	Breadth	Finish
1999 G	22mm	22mm	Gold PVD



Towel Ring-Black

Art No.	Finish
1942 B	Black

Towel Ring Black & CP

Art No.	Finish
1942 B-CP	CP

BEAR BATH ACCESSORIES

Set of 5 Pcs (2401, 2402, 2403, 2405, 2407)



Soap Dish Bear

Art No.	Finish
2401	Antique Tin



Towel Ring Bear

Art No.	Finish
2402	Antique Tin



Tumbler Holder Bear

Art No.	Finish
2403	Antique Tin



Robe Hook Bear

Art No.	Finish
2405	Antique Tin



Towel Rail Bear

Art No.	Length	Finish
2407	600mm(24")	Antique Tin



Toilet Paper Holder Bear

Art No.	Finish
2412	Antique Tin

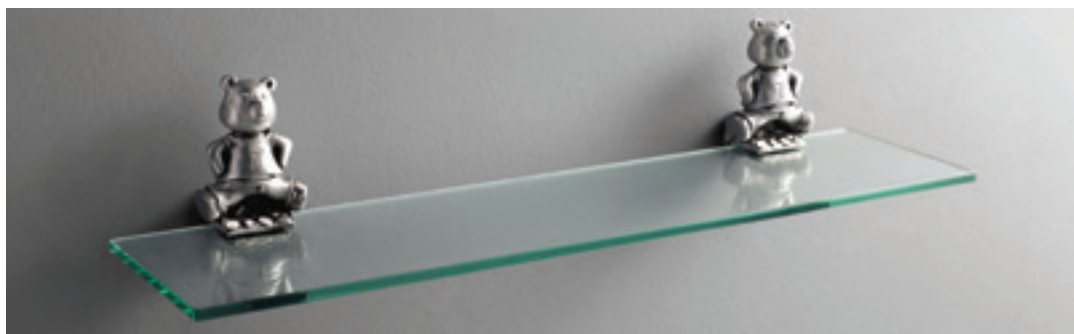

Glass Shelf Bear

Art No.	Length	Finish
2418	600mm(24")	Antique Tin

DIVA BATH ACCESSORIES

Set of 5 Pcs (2421, 2422, 2423, 2425, 2427)



Soap Dish Diva

Art No.	Finish
2421	Antique Tin



Towel Ring Diva

Art No.	Finish
2422	Antique Tin



Tumbler Holder Diva

Art No.	Finish
2423	Antique Tin



Robe Hook Diva

Art No.	Finish
2425	Antique Tin



Towel Rail Diva

Art No.	Length	Finish
2427	600mm(24")	Antique Tin



Toilet Paper Holder Diva

Art No.	Finish
2432	Antique Tin



Glass Shelf Diva

Art No.	Length	Finish
2438	600mm(24")	Antique Tin

ANGEL BATH ACCESSORIES

Set of 5 Pcs (2461, 2462, 2463, 2465, 2467)



Soap Dish Angel

Art No.	Finish
2461	Antique Tin



Towel Ring Angel

Art No.	Finish
2462	Antique Tin



Tumbler Holder Angel

Art No.	Finish
2463	Antique Tin



Robe Hook Angel

Art No.	Finish
2465	Antique Tin



Towel Rail Angel

Art No.	Length	Finish
2467	600mm(24")	Antique Tin



Toilet Paper Holder Angel

Art No.	Finish
2472	Antique Tin

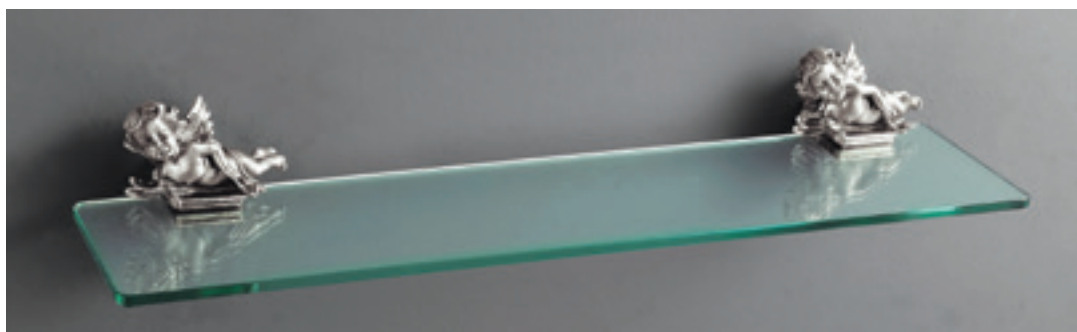

Glass Shelf Angel

Art No.	Length	Finish
2478	600mm(24")	Antique Tin



**Electric Heated Towel Rack
(Wall Mounted)**
- Wire length 155mm

Art No.	Length	Width	Material	Finish
2710	550mm	320mm	SS 201	Polished



Bath Stand Subtle

Art No.	Material	Finish
2985	Brass	Polished CP

Best Seller



**Connection Pipe
Braided - SS304 (Italia)**
For Geysers & Pressue Pump

- Pressure 8 Bar.
- Temp. 90° C.
- Braided Pipe are better then PVC Pipe with higher pressure & Temp. capacity.
- Braiding helps to avoid injury (Splashing of hot water overhuman in case of breakage).
- Inner Outer Thread pipes can be used as extension in case of long pipe.

Art No.	Thread Size 1	Type	Thread Size 2	Type	Length	Material	Finish
3012	15mm(1/2")	Inner	15mm(1/2")	Inner	300mm(12")	SS 304	Steel
3018	15mm(1/2")	Inner	15mm(1/2")	Inner	450mm(18")	SS 304	Steel
3024	15mm(1/2")	Inner	15mm(1/2")	Inner	600mm(24")	SS 304	Steel
3036	15mm(1/2")	Inner	15mm(1/2")	Inner	900mm(36")	SS 304	Steel
3048	15mm(1/2")	Inner	15mm(1/2")	Inner	1200mm(48")	SS 304	Steel
3049	10mm(3/8")	Inner	10mm(3/8")	Outer	300mm(12")	SS 304	Steel
3051	10mm(3/8")	Inner	10mm(3/8")	Inner	450mm(18")	SS 304	Steel
3052	10mm(3/8")	Inner	10mm(3/8")	Inner	600mm(24")	SS 304	Steel
3055	15mm(1/2")	Inner	15mm(1/2")	Outer	450mm(18")	SS 304	Steel
3057	15mm(1/2")	Inner	15mm(1/2")	Outer	600mm(24")	SS 304	Steel
3061	20mm(3/4")	Inner	20mm(3/4")	Inner	450mm(18")	SS 304	Steel
3063	20mm(3/4")	Inner	20mm(3/4")	Inner	600mm(24")	SS 304	Steel
3065	20mm(3/4")	Inner	20mm(3/4")	Inner	900mm(36")	SS 304	Steel
3084	25mm(1")	Inner	25mm(1")	Inner	600mm(24")	SS 304	Steel
3100	10mm(3/8")	Inner	15mm(1/2")	Inner	450mm(18")	SS 304	Steel



Connection Pipe With Valve-SS 304

- Pressure 8 Bar.
- Temp. 90° C.

Art No.	Thread Size 1	Type	Thread Size 2	Type	Length	Material	Finish
3118	15mm(1/2")	Inner	15mm(1/2")	Outer	450mm(18")	SS 304	Steel
3124	15mm(1/2")	Inner	15mm(1/2")	Outer	600mm(24")	SS 304	Steel
3136	15mm(1/2")	Inner	15mm(1/2")	Outer	900mm(36")	SS 304	Steel



**Connection Pipe Threaded
Italia For Basin Mixer-SS 304 (Pair)**

- Pressure 8 Bar.
- Temp. capacity 90° C.

Art No.	Thread Size 1	Type	Thread Size 2	Type	Length	Material	Finish
3218	15mm(1/2")	Inner	M10	Outer	450mm(18")	SS 304	Steel
3224	15mm(1/2")	Inner	M10	Outer	600mm(24")	SS 304	Steel
3238	15mm(1/2")	Inner	M12	Outer	450mm(18")	SS 304	Steel
3244	15mm(1/2")	Inner	M12	Outer	600mm(24")	SS 304	Steel



Connection Pipe Silver-Brass CP Tail

- Pressure 5 Bar.
- Temp. 85° C.

Art No.	Thread Size 1	Type	Thread Size 2	Type	Length	Material	Colour
3548	15mm(1/2")	Inner	15mm(1/2")	Inner	300mm(12")	PVC	Silver
3550	15mm(1/2")	Inner	15mm(1/2")	Inner	450mm(18")	PVC	Silver
3552	15mm(1/2")	Inner	15mm(1/2")	Inner	600mm(24")	PVC	Silver
3554	15mm(1/2")	Inner	15mm(1/2")	Inner	900mm(36")	PVC	Silver



Connection Pipe Braided White-Brass CP Tail

- Pressure 5 Bar.
- Temp. 85° C.

Art No.	Thread Size 1	Type	Thread Size 2	Type	Length	Material	Colour
3574	15mm(1/2")	Inner	15mm(1/2")	Inner	300mm(12")	PVC	White
3576	15mm(1/2")	Inner	15mm(1/2")	Inner	450mm(18")	PVC	White
3578	15mm(1/2")	Inner	15mm(1/2")	Inner	600mm(24")	PVC	White
3580	15mm(1/2")	Inner	15mm(1/2")	Inner	900mm(36")	PVC	White



Connection Pipe Braided White-Brass Tail

- Pressure 5 Bar.
- Temp. 85° C.

Art No.	Thread Size 1	Type	Thread Size 2	Type	Length	Material	Colour
3590	15mm(1/2")	Inner	15mm(1/2")	Inner	300mm(12")	PVC	White
3592	15mm(1/2")	Inner	15mm(1/2")	Inner	450mm(18")	PVC	White
3594	15mm(1/2")	Inner	15mm(1/2")	Inner	600mm(24")	PVC	White
3596	15mm(1/2")	Inner	15mm(1/2")	Inner	900mm(36")	PVC	White
3597	15mm(1/2")	Inner	15mm(1/2")	Inner	1200mm(48")	PVC	White
3598	15mm(1/2")	Inner	15mm(1/2")	Inner	1500mm(60")	PVC	White



Connection Pipe Ivory-Brass Tail & CP Nut

- Pressure 5 Bar.
- Temp. 85° C.

Art No.	Thread Size 1	Type	Thread Size 2	Type	Length	Material	Colour
3612	15mm(1/2")	Inner	15mm(1/2")	Inner	300mm(12")	PVC	Ivory
3618	15mm(1/2")	Inner	15mm(1/2")	Inner	450mm(18")	PVC	Ivory
3624	15mm(1/2")	Inner	15mm(1/2")	Inner	600mm(24")	PVC	Ivory
3636	15mm(1/2")	Inner	15mm(1/2")	Inner	900mm(36")	PVC	Ivory
3648	15mm(1/2")	Inner	15mm(1/2")	Inner	1200mm(48")	PVC	Ivory
3660	15mm(1/2")	Inner	15mm(1/2")	Inner	1500mm(60")	PVC	Ivory
3672	15mm(1/2")	Inner	15mm(1/2")	Inner	1800mm(72")	PVC	Ivory



Connection Pipe Ivory-Brass Tail & Nut

- Pressure 5 Bar.
- Temp. 85° C.

Art No.	Thread Size 1	Type	Thread Size 2	Type	Length	Material	Colour
3712	15mm(1/2")	Inner	15mm(1/2")	Inner	300mm(12")	PVC	Ivory
3718	15mm(1/2")	Inner	15mm(1/2")	Inner	450mm(18")	PVC	Ivory
3724	15mm(1/2")	Inner	15mm(1/2")	Inner	600mm(24")	PVC	Ivory
3736	15mm(1/2")	Inner	15mm(1/2")	Inner	900mm(36")	PVC	Ivory
3748	15mm(1/2")	Inner	15mm(1/2")	Inner	1200mm(48")	PVC	Ivory
3760	15mm(1/2")	Inner	15mm(1/2")	Inner	1500mm(60")	PVC	Ivory
3772	15mm(1/2")	Inner	15mm(1/2")	Inner	1800mm(72")	PVC	Ivory



Copper Connection Pipe-With 2 Nut & Washer

Art No.	Thread Size 1	Type	Thread Size 2	Type	Length	Material	Finish
4412	15mm(1/2")	Inner	15mm(1/2")	Inner	300mm(12")	Copper	Polished CP
4418	15mm(1/2")	Inner	15mm(1/2")	Inner	450mm(18")	Copper	Polished CP
4424	15mm(1/2")	Inner	15mm(1/2")	Inner	600mm(24")	Copper	Polished CP
4512	(Nut 15mm(1/2") for Copper Pipe.						Brass Polished CP



Waste Pipe-Plastic Tail

Art No.	Thread Size	Type	Length	Material	Colour
4921	32mm(1-1/4")	Inner	750mm(30")	PVC	Ivory



Waste Pipe-Brass Nut Tail

Art No.	Thread Size	Type	Length	Material	Colour
4930	32mm(1-1/4")	Inner	750mm(30")	PVC	Ivory
4930.02 (Nut 32mm)				Brass	CP
4936	32mm(1-1/4")	Inner	900mm(36")	PVC	Ivory
4945	40mm(1-1/2")	Inner	750mm(30")	PVC	Ivory
4947	40mm(1-1/2")	Inner	900mm(36")	PVC	Ivory
4950	50mm(2")	Inner	750mm(30")	PVC	Ivory



Waste Pipe-Urinal

Art No.	Thread Size	Type	Length	Material	Colour
4965	95mm(3-3/4")	Inner	750mm(30")	PVC	Ivory
4967	95mm(3-3/4")	Inner	900mm(36")	PVC	Ivory



Waste Pipe-Collapsible

- Maximum Length 840mm
- Minimum Length 350mm

Art No.	Thread Size	Type	Material	Colour
4972	32mm(1-1/4")	Inner	Polypropylene	White



Waste Pipe-Collapsible

- Maximum Length 840mm
- Minimum Length 350mm

Art No.	Thread Size	Type	Material	Colour
4975	32mm(1-1/4")	Inner	Polypropylene	White
4975.02 (Nut 32mm for 4975)			Brass	CP



Adapter Reducer

Art No.	Thread Size 1	Type	Thread Size 2	Type	Material	Colour
4999	32mm(1-1/4")	Inner	40mm(1-1/2")	Outer	PVC	Grey



Waste Coupling

Art No.	Thread Size	Type	Length	Material	Finish
5150	32mm(1-1/4")	Outer	75mm(3")	Brass	Polished CP

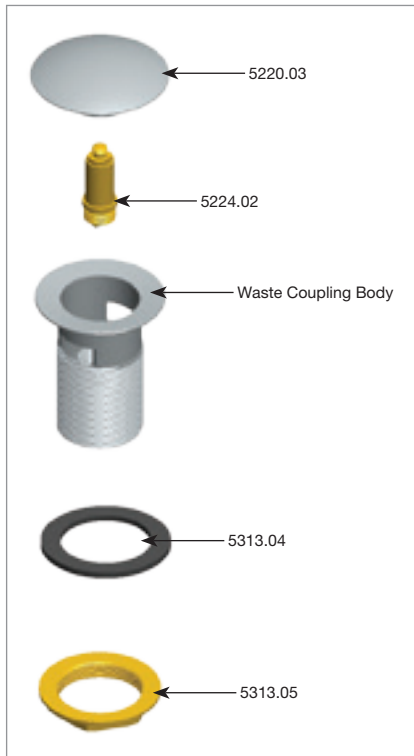

Breakup view of 5220 Parts



Waste Coupling Pop Up Full Cap

Art No.	Thread Size	Type	Length	Material	Finish
5219 H/T	32mm(1-1/4")	Outer	125mm(5")	Brass	Polished CP
5220 H/T	32mm(1-1/4")	Outer	75mm(3")	Brass	Polished CP
5221 F/T	32mm(1-1/4")	Outer	75mm(3")	Brass	Polished CP
5222 F/T	32mm(1-1/4")	Outer	125mm(5")	Brass	Polished CP
5220.03 (Full Cap for Pop Up)				Brass	Polished CP



Waste Coupling Pop Up

Art No.	Thread Size	Type	Length	Material	Finish
5223 H/T	32mm(1-1/4")	Outer	75mm(3")	Brass	Polished CP
5224 F/T	32mm(1-1/4")	Outer	75mm(3")	Brass	Polished CP
5224.02 (Spindle for Pop up Waste Coupling)				Brass	Brass
5224.03 (Cap for Pop up Waste Coupling)				Brass	Polished CP
5226 F/T	40mm(1-1/2")	Outer	50mm(2")	Brass	Polished CP
5227 F/T	32mm(1-1/4")	Outer	125mm(5")	Brass	Polished CP
5228 H/T	32mm(1-1/4")	Outer	125mm(5")	Brass	Polished CP
5230 F/T	32mm(1-1/4")	Outer	215mm(8.5")	Brass	Polished CP

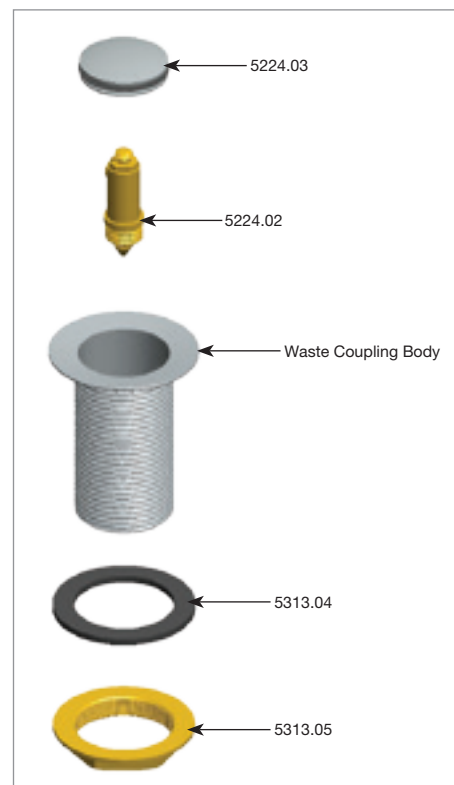

Breakup view of 5224 Parts

Note: 5313.04, 5313.05 Refer to Page no. 67



Waste Coupling Flip

Art No.	Thread Size	Type	Length	Material	Finish
5243 H/T	32mm(1-1/4")	Outer	75mm(3")	Brass	Polished CP
5244 F/T	32mm(1-1/4")	Outer	75mm(3")	Brass	Polished CP



Waste Coupling

Art No.	Thread Size	Type	Length	Material	Finish
5280 F/T	25mm(1")	Outer	75mm(3")	Brass	Polished CP
5283 H/T	32mm(1-1/4")	Outer	75mm(3")	Brass	Polished CP
5284 F/T	32mm(1-1/4")	Outer	75mm(3")	Brass	Polished CP
5285 F/T	32mm(1-1/4")	Outer	125mm(5")	Brass	Polished CP



Aussie Waste Coupling

Art No.	Thread Size	Type	Length	Material	Finish
5292 F/T	32mm(1-1/4")	Outer	75mm(3")	Brass	Polished CP
5293 H/T	32mm(1-1/4")	Outer	75mm(3")	Brass	Polished CP
5295 H/T	32mm(1-1/4")	Outer	150mm(6")	Brass	Polished CP
5296 F/T	32mm(1-1/4")	Outer	150mm(6")	Brass	Polished CP



Waste Coupling Ocular (Regular)

Art No.	Thread Size	Type	Length	Material	Finish
5303 H/T	32mm(1-1/4")	Outer	75mm(3")	Brass	Polished CP
5313 F/T	32mm(1-1/4")	Outer	75mm(3")	Brass	Polished CP
5323 H/T	40mm(1-1/2")	Outer	75mm(3")	Brass	Polished CP
5333 F/T	40mm(1-1/2")	Outer	75mm(3")	Brass	Polished CP
5333.04, 5333.05 (Rubber Washer)	Refer to page no. 67				



Waste Coupling Long Thread

Art No.	Thread Size	Type	Length	Material	Finish
5345	32mm(1-1/4")	Outer	125mm(5")	Brass	Polished CP
5348	32mm(1-1/4")	Outer	215mm(8.5")	Brass	Polished CP
5355	40mm(1-1/2")	Outer	125mm(5")	Brass	Polished CP
5358	40mm(1-1/2")	Outer	215mm(8.5")	Brass	Polished CP
5365	50mm(2")	Outer	125mm(5")	Brass	Polished CP
5365.02, 5365.03 (Rubber Washer)	Refer to page no. 67				
5370	40mm(1-1/2")	Outer	50mm(2")	Brass	Polished CP



Chain Plug Classic

Art No.	Thread Size	Length	Material	Finish
5380	32mm(1-1/4")	32mm(1-1/4")	Brass	Polished CP
5385	40mm(1-1/2")	40mm(1-1/2")	Brass	Polished CP
5385.02 (Rubber Bush)			Rubber	
5385.04 (Chain for 5380 & 5385)				Polished CP





Bathtub Overflow Set Knob Control (On - Off)

Art No.	Thread Size	Material	Finish
5550	40mm(1-1/2")	Copper	Polished CP



**Bathtub Overflow Set
(With Flip Waste)**

Art No.	Thread Size	Material	Finish
5565	40mm(1-1/2")	Brass	Polished CP



**Bathtub Overflow Set
(With Pop Up Waste)**

Art No.	Thread Size	Material	Finish
5575	40mm(1-1/2")	Brass	Polished CP
5575.05		Brass	Polished CP
(Round Head Bolt (killi))			
5575.02.03	Cap 40mm for BT Waste Coupling with Seal)	Brass	Polished CP



**Bathtub Overflow Set
(With Chain Plug Waste Coupling)**

Art No.	Thread Size	Material	Finish
5585	40mm(1-1/2")	Brass	Polished CP



- Used Specially where waste Coupling & Wall Hole for (P-Trap or Bottle Trap) are not aligned.
- Can be used as trap as shown in pic.

**Trap Pipe Steel
(With Brass Nut)**
- You can bend as per your fitting

Art No.	Thread Size	Length	Material	Finish
5765	32mm(1-1/4")	750mm(30")	SS 304	Polished CP
5776	40mm(1-1/2")	750mm(30")	SS 304	Polished CP



Bottle Trap Escada

Art No.	Thread Size	Type	Length	Material	Finish
5790	32mm(1-1/4")	Inner	300mm(12")	Brass	Polished CP
5792	32mm(1-1/4")	Inner	450mm(18")	Brass	Polished CP



Pipe For Bottle Trap Escada Special

- Fits with Jaquar 769, Grohe, Kohler.
- Gold & Other Finishes available on Request

Art No.	Dia	Type	Length	Material	Finish	With Collar
5795	32mm(1-1/4")	Inner	225mm(9")	Brass	Polished CP	✗
5795 A	32mm(1-1/4")	Inner	225mm(9")	Brass	Polished CP	✓
5796	32mm(1-1/4")	Inner	300mm(12")	Brass	Polished CP	✗
5796 A	32mm(1-1/4")	Inner	300mm(12")	Brass	Polished CP	✓
5797	32mm(1-1/4")	Inner	375mm(15")	Brass	Polished CP	✗
5797 A	32mm(1-1/4")	Inner	375mm(15")	Brass	Polished CP	✓
5798	32mm(1-1/4")	Inner	450mm(18")	Brass	Polished CP	✗
5798 A	32mm(1-1/4")	Inner	450mm(18")	Brass	Polished CP	✓
5799	32mm(1-1/4")	Inner	600mm(24")	Brass	Polished CP	✗
5799 A	32mm(1-1/4")	Inner	600mm(24")	Brass	Polished CP	✓



Bottle Trap Oval

Art No.	Thread Size	Type	Length	Material	Finish
5802	32mm(1-1/4")	Inner	300mm(12")	Brass	Polished CP



Bottle Trap Square

Art No.	Thread Size	Type	Length	Material	Finish
5803	32mm(1-1/4")	Inner	300mm(12")	Brass	Polished CP



Bottle Trap

Art No.	Thread Size	Type	Length	Material	Finish
5809	32mm(1-1/4")	Inner	225mm(9")	Brass	Polished CP
5812	32mm(1-1/4")	Inner	300mm(12")	Brass	Polished CP
5812.02 (Nut for Bottle Trap)				Brass	Polished CP
5812.07 (Taper Washer for Bottle Trap)				Rubber	
5812.08 (Washer of Bottle Trap Nut-Pack of 3)					
5818	32mm(1-1/4")	Inner	450mm(18")	Brass	Polished CP
5824	32mm(1-1/4")	Inner	600mm(24")	Brass	Polished CP
5832	40mm(1-1/2")	Inner	300mm(12")	Brass	Polished CP
5838	40mm(1-1/2")	Inner	450mm(18")	Brass	Polished CP
5844	40mm(1-1/2")	Inner	600mm(24")	Brass	Polished CP



Bottle Trap

Art No.	Thread Size	Type	Length	Material	Finish
5846	32mm(1-1/4")	Inner	300mm(12")	Brass	Polished CP



Pipe For Bottle Trap-Regular

Art No.	Dia	Type	Length	Material	Finish	With Collar
5858	32mm(1-1/4")	Inner	225mm(9")	Brass	Polished CP	✗
5859	32mm(1-1/4")	Inner	225mm(9")	Brass	Polished CP	✓
5862	32mm(1-1/4")	Inner	300mm(12")	Brass	Polished CP	✗
5863	32mm(1-1/4")	Inner	300mm(12")	Brass	Polished CP	✓
5868	32mm(1-1/4")	Inner	450mm(18")	Brass	Polished CP	✗
5869	32mm(1-1/4")	Inner	450mm(18")	Brass	Polished CP	✓
5874	32mm(1-1/4")	Inner	600mm(24")	Brass	Polished CP	✗
5875	32mm(1-1/4")	Inner	600mm(24")	Brass	Polished CP	✓



Bottle Trap Italia

Art No.	Thread Size	Type	Length	Material	Finish
5889	32mm(1-1/4")	Inner	225mm(9")	ABS	Polished CP



P Trap

Art No.	Thread Size	Type	Length	Material	Finish
5892	32mm(1-1/4")	Inner	225mm(9")	Brass	Polished CP
5892.01 (Bend Horizontal Pipe)			225mm(9")	Brass	Polished CP
5896	32mm(1-1/4")	Inner	300mm(12")	Brass	Polished CP
5896.01 (Bend Horizontal Pipe)			300mm(12")	Brass	Polished CP
5896.08 (Flange for Horizontal Pipe of P & Bottle Trap)				Brass	Polished CP
5897	32mm(1-1/4")		450mm(18")	Brass	Polished CP
5898	40mm(1-1/2")	Inner	300mm(12")	Brass	Polished CP



P Trap

Art No.	Thread Size	Type	Length	Material	Finish
5915	32mm(1-1/4")	Inner	300mm(12")	ABS	Polished CP
5920	32mm(1-1/4")	Inner	300mm(12")	ABS	White



S Trap Floor (Ground) Outlet

Art No.	Thread Size	Type	Breadth	Material	Finish
5960	32mm(1-1/4")	Inner	32mm(1-1/4")	Brass	Polished CP



**Self Closing-Urinal Cock
(Time Delayed)**

Art No.	Thread Size 1	Type	Thread Size 2	Type	Material	Finish
6202	15mm(1/2")	Inner	15mm(1/2")	Inner	Brass	Polished CP



Self Closing-Urinal Cock

Art No.	Thread Size 1	Type	Thread Size 2	Material	Finish
6212	15mm(1/2")	Outer	15mm(1/2")	Brass	Polished CP



Urinal Waste Coupling-Dome

Art No.	Thread Size 1	Type	Length	Material	Finish
6242	32mm(1-1/4")	Outer	75mm(3")	Brass	Polished CP



Urinal Spreader Sleek

Art No.	Thread Size 1	Type	Material	Finish
6330	15mm(1/2")	Outer	Brass	Polished CP



CP Urinal Brackets

Art No.	Material	Finish
6350	Brass	CP

Coming Soon

**Self Closing with Flow Control-Urinal Cock
(Time Delayed)**

Art No.	Thread Size 1	Type	Thread Size 2	Type	Material	Finish
6203	15mm(1/2")	Outer	15mm(1/2")	Outer	Brass	Polished CP
11855 (Replacement Kit (Refer to Page no. 60))						



Self Closing-Urinal Cock Ocular

Art No.	Thread Size 1	Type	Thread Size 2	Material	Finish
6232	15mm(1/2")	Outer	15mm(1/2")	Brass	Polished CP
6233	20mm(3/4")	Inner	15mm(1/2")	Brass	Polished CP



Urinal Spreader Ocular-Regular

Art No.	Thread Size	Type	Material	Finish
6320	15mm(1/2")	Outer	Brass	Polished CP



Urinal Spreader Parry

Art No.	Thread Size 1	Type	Material	Finish
6340	15mm(1/2")	Outer	Brass	Polished CP



Urinal Bracket-Pair

Art No.	Material	Finish
6353	(Mild Steel)	Zinc Plated



Perfumed Urinal Mat With Freshner Block-Anti Odour

Art No.	Colour
6355	White

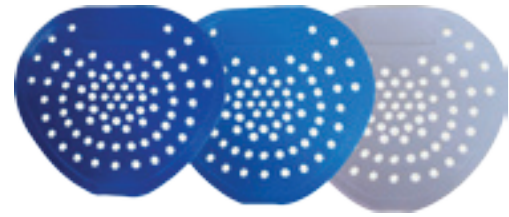

Perfumed Urinal Mat Screen-Anti Odour

Art No.	Length	Breadth	Colour
6363 Fruity	200mm(8")	180mm(7")	Dark Blue
6364 Mint	200mm(8")	180mm(7")	Light Blue
6365 Lemon	200mm(8")	180mm(7")	White



Jet Spray Set Crystal
- Suitable For Imported EWC's

Art No.	Thread Size 1	Length	Material	Finish
7004	15mm(1/2")	600mm(24")	Brass	Polished CP
7004.08 (Jet Plate)			Brass	Polished CP
7006	15mm(1/2")	900mm(36")	Brass	Polished CP
7008	15mm(1/2")	1200mm(48")	Brass	Polished CP

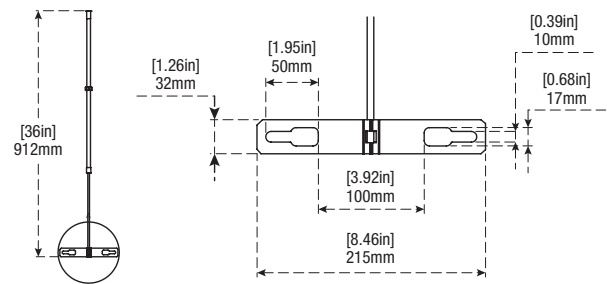

Jet Spray Set- Flair
- Suitable For Imported EWC's

Art No.	Thread Size 1	Length	Material	Finish
7010	15mm(1/2")	600mm(24")	Brass	Polished CP
7010.08 (Jet Plate)			Brass	Polished CP
7011	15mm(1/2")	900mm(36")	Brass	Polished CP

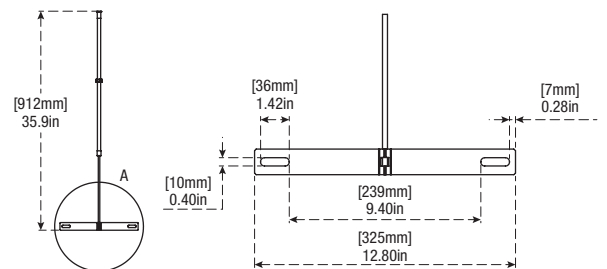

Jet Spray Set
- For Regular constellation, Cascade Multi Jet

Art No.	Thread Size 1	Length	Material	Finish
7014	15mm(1/2")	600mm(24")	Brass	Polished CP
7014.07 (Jet Plate)			Brass	Polished CP
7016	15mm(1/2")	900mm(36")	Brass	Polished CP
7018	15mm(1/2")	1200mm(48")	Brass	Polished CP

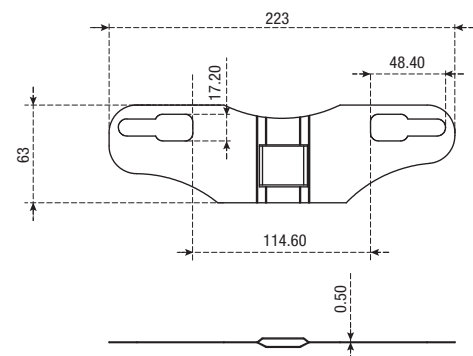



Health Faucet Valve

- Need to Additional line from existing point.
- Remove Tap install in front of valve & Health Faucet/Jet also.

Art No.	Thread Size 1	Type	Thread Size 2	Type	Material	Finish
7175	15mm(1/2")	Outer	15mm(1/2")	Inner	Brass	Polished CP



Hook

Art No.	Material	Finish
7182	ABS	Polished CP



CP Hook- Regular

Art No.	Material	Finish
7201	Brass	Polished



CP Hook- Heavy

Art No.	Material	Finish
7202	Brass	Polished



Health Faucet- Chicago

Art No.	Thread Size	Length	Material	Finish
7204 With Silver Tube & Hook	15mm(1/2")	1000mm(40")	ABS	Polished CP
7206 With Silver Tube & Hook	15mm(1/2")	1500mm(60")	ABS	Polished CP
7214 With CP Tube & Hook	15mm(1/2")	1000mm(40")	ABS	Polished CP
7216 With CP Tube & Hook	15mm(1/2")	1500mm(60")	ABS	Polished CP
7280 Lever With Hook	15mm(1/2")		ABS	Polished CP



Health Faucet

Art No.	Thread Size	Length	Material	Finish
7286 With CP Tube & Hook	15mm(1/2")	1000mm(40")	ABS	Polished CP
7287 With CP Tube & Hook	15mm(1/2")	1500mm(60")	ABS	Polished CP
7288 With Silver Tube & Hook	15mm(1/2")	1000mm(40")	ABS	Polished CP
7289 With Silver Tube & Hook	15mm(1/2")	1500mm(60")	ABS	Polished CP
7290 Lever With Hook	15mm(1/2")		ABS	Polished CP



**Health Faucet- Ocular
(All Brass)**

Art No.	Thread Size	Length	Material	Finish
7354 With Silver Tube & Hook	15mm(1/2")	1000mm(40")	Brass	Polished CP
7356 With Silver Tube & Hook	15mm(1/2")	1500mm(60")	Brass	Polished CP
7364 With CP Tube & Hook	15mm(1/2")	1000mm(40")	Brass	Polished CP
7366 With CP Tube & Hook	15mm(1/2")	1500mm(60")	Brass	Polished CP
7380 Lever With Hook	15mm(1/2")		Brass	Polished CP



Health Faucet

Art No.	Thread Size	Length	Material	Finish
7384 With CP Tube & Hook	15mm(1/2")	1000mm(40")	ABS	Polished CP
7385 With CP Tube & Hook	15mm(1/2")	1500mm(60")	ABS	Polished CP
7386 With Silver Tube & Hook	15mm(1/2")	1000mm(40")	ABS	Polished CP
7387 With Silver Tube & Hook	15mm(1/2")	1500mm(60")	ABS	Polished CP
7388 Lever With Hook			ABS	Polished CP



Health Faucet-Sleek

Art No.	Thread Size	Length	Material	Finish
7480 Lever With Hook	15mm(1/2")		ABS	Polished CP
7484 With Silver Tube & Hook	15mm(1/2")	1000mm(40")	ABS	Polished CP
7486 With Silver Tube & Hook	15mm(1/2")	1500mm(60")	ABS	Polished CP
7494 With CP Tube & Hook	15mm(1/2")	1000mm(40")	ABS	Polished CP
7496 With CP Tube & Hook	15mm(1/2")	1500mm(60")	ABS	Polished CP
7480.01.01 (Lever for Sleek Body)			ABS	Polished CP



Health Faucet-Omega

Art No.	Thread Size	Length	Material	Finish
7501 Lever With Hook			ABS	Polished CP
7504 With Silver Tube & Hook	15mm(1/2")	1000mm(40")	ABS	Polished CP
7506 With Silver Tube & Hook	15mm(1/2")	1500mm(60")	ABS	Polished CP
7514 With CP Tube & Hook	15mm(1/2")	1000mm(40")	ABS	Polished CP
7516 With CP Tube & Hook	15mm(1/2")	1500mm(60")	ABS	Polished CP



Health Faucet-Jadore

Art No.	Thread Size	Length	Material	Finish
7540 Lever With Hook			ABS	Polished CP
7541 With CP Tube & Hook	15mm(1/2")	1000mm(40")	ABS	Polished CP
7543 With CP Tube & Hook	15mm(1/2")	1500mm(60")	ABS	Polished CP
7548 With Silver Tube & Hook	15mm(1/2")	1000mm(40")	ABS	Polished CP
7550 With Silver Tube & Hook	15mm(1/2")	1500mm(60")	ABS	Polished CP

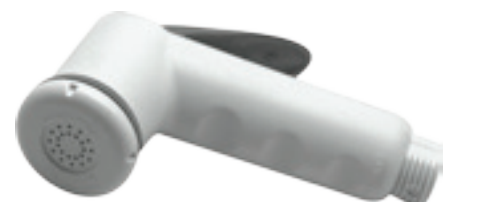

Health Faucet

Art No.	Thread Size	Length	Material	Colour
7600 Lever With Hook			ABS	White
7601 With Silver Tube & Hook	15mm(1/2")	1000mm(40")	ABS	Polished CP
7602 With Silver Tube & Hook	15mm(1/2")	1500mm(60")	ABS	Polished CP
7603 With CP Tube & Hook	15mm(1/2")	1000mm(40")	ABS	Polished CP
7604 With CP Tube & Hook	15mm(1/2")	1500mm(60")	ABS	Polished CP



Shower Tube Regular

Art No.	Thread Size 1	Thread Size 2	Length	Material	Finish
8014	15mm (1/2")	15mm(1/2")	1000mm (40")	SS 304	Polished
8016	15mm (1/2")	15mm(1/2")	1500mm(60")	SS 304	Polished
8018	15mm (1/2")	15mm(1/2")	2000mm(80")	SS 304	Polished



Silver Shower Tube

Art No.	Thread Size 1	Thread Size 2	Length	Material	Colour
8024	15mm (1/2")	15mm(1/2")	1000mm (40")	PVC	Silver
8026	15mm (1/2")	15mm(1/2")	1500mm(60")	PVC	Silver



Silver Shower Tube-Premium

Art No.	Thread Size 1	Thread Size 2	Length	Material	Colour
8030	15mm (1/2")	15mm(1/2")	1000mm (40")	PVC	Silver
8032	15mm (1/2")	15mm(1/2")	1500mm(60")	PVC	Silver



Flexible Shower Tube

Art No.	Thread Size 1	Thread Size 2	Length	Material	Colour
8034	15mm (1/2")	15mm(1/2")	1000mm (40")	PVC	White
8036	15mm (1/2")	15mm(1/2")	1500mm(60")	PVC	White
8038	15mm (1/2")	15mm(1/2")	2000mm(80")	PVC	White



Telephone Shower-Rectangular

Art No.	Thread Size 1	Thread Size 2	Length	Material	Finish
8137 Lever With Hook				ABS	Polished CP
8138 With CP Tube & Hook	15mm (1/2")	15mm (1/2")	1000mm(40")	ABS	Polished CP
8139 With CP Tube & Hook	15mm (1/2")	15mm (1/2")	1500mm(60")	ABS	Polished CP
8140 With Silver Tube & Hook	15mm (1/2")	15mm (1/2")	1000mm(40")	ABS	Polished CP
8141 With Silver Tube & Hook	15mm (1/2")	15mm (1/2")	1500mm(60")	ABS	Polished CP



Telephone Shower-Milano

Art No.	Thread Size 1	Thread Size 2	Length	Material	Finish
8201 Lever With Hook	15mm (1/2")			ABS	Polished CP
8214 With CP Tube & Hook	15mm (1/2")	15mm (1/2")	1000mm(40")	ABS	Polished CP
8216 With CP Tube & Hook	15mm (1/2")	15mm (1/2")	1500mm(60")	ABS	Polished CP
8234 With Silver Tube & Hook	15mm (1/2")	15mm (1/2")	1000mm(40")	ABS	Polished CP
8236 With Silver Tube & Hook	15mm (1/2")	15mm (1/2")	1500mm(60")	ABS	Polished CP



Telephone Shower-Niagra

Art No.	Thread Size	Thread Size 2	Length	Material	Finish
8401 Lever With Hook				ABS	Polished CP
8414 With CP Tube & Hook	15mm (1/2")	15mm (1/2")	1000mm(40")	ABS	Polished CP
8416 With CP Tube & Hook	15mm (1/2")	15mm (1/2")	1500mm(60")	ABS	Polished CP
8434 With Silver Tube & Hook	15mm (1/2")	15mm (1/2")	1000mm(40")	ABS	Polished CP
8436 With Silver Tube & Hook	15mm (1/2")	15mm (1/2")	1500mm(60")	ABS	Polished CP



**Rain Shower Scala Super Thin
- With One Inlet**

Art No.	Thread Size	Length	Material	Finish
8440	15mm (1/2")	200mm(8")	SS 304	Polished



Rain Shower Series-Round

Art No.	Thread Size	Dia	Height	Material	Finish
8476	15mm (1/2")	200mm(8")	2mm	SS 304	Polished
8477	15mm (1/2")	250mm(10")	2mm	SS 304	Polished
8478	15mm (1/2")	300mm(12")	2mm	SS 304	Polished
8479	15mm (1/2")	350mm(14")	2mm	SS 304	Polished
8480	15mm (1/2")	400mm(16")	2mm	SS 304	Polished



Rain Shower Series-Square

Art No.	Thread Size	Length	Breadth	Height	Material	Finish
8484	15mm(1/2")	200mm(8")	200mm(8")	2mm	SS 304	Polished
8485	15mm(1/2")	250mm(10")	250mm(10")	2mm	SS 304	Polished
8486	15mm(1/2")	300mm(12")	300mm(12")	2mm	SS 304	Polished
8487	15mm(1/2")	350mm(14")	350mm(14")	2mm	SS 304	Polished
8488	15mm(1/2")	400mm(16")	400mm(16")	2mm	SS 304	Polished



Ceiling Shower Series-Square

Art No.	Thread Size	Length	Breadth	Height	Material	Finish
8490	15mm (1/2")	500mm(20")	500mm(20")	2mm	SS 304	Polished



8688

Ceiling Shower Series-Round

Art No.	Thread Size	Dia	Height	Material	Finish
8685	15mm (1/2")	200mm(8")	100mm(4")	SS 304	Polished
8686	15mm (1/2")	300mm(12")	100mm(4")	SS 304	Polished
8687	15mm (1/2")	400mm(16")	100mm(4")	SS 304	Polished
8688	15mm (1/2")	200mm(8")	200mm(8")	SS 304	Polished

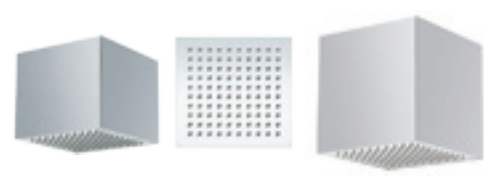

8695

Ceiling Shower Series-Square

Art No.	Thread Size	Length	Breadth	Height	Material	Finish
8692	15mm(1/2")	200mm(8")	200mm(8")	100mm(4")	SS 304	Polished
8693	15mm(1/2")	300mm(12")	300mm(12")	100mm(4")	SS 304	Polished
8694	15mm(1/2")	400mm(16")	400mm(16")	100mm(4")	SS 304	Polished
8695	15mm(1/2")	200mm(8")	200mm(8")	200mm(8")	SS 304	Polished





Shower Classic
(All Brass)

Art No.	Thread Size	Material	Finish
8505	15mm (1/2")	Brass	Polished CP



Best Seller

Shower Victorian

Art No.	Thread Size	Material	Finish
8520	15mm (1/2")	ABS	Polished CP

8520.51 (Ball joint Connector Kit (replacement) for Shower



2 Flows

Over Head Shower

Art No.	Thread Size	Material	Finish
8531	15mm (1/2")	ABS	Polished CP



Over Head Shower

Art No.	Thread Size	Material	Finish
8541	15mm (1/2")	ABS	Polished CP



Over Head Shower

Art No.	Thread Size	Dia	Material	Finish
8545	15mm (1/2")	150mm(6")	ABS	Polished CP



5 Flows,
Rain, Massage,
Mist, Rain+Mist,
Rain-Massage

Over Head Shower

Art No.	Thread Size	Dia	Material	Finish
8548	15mm (1/2")	150mm(6")	ABS	Polished CP



2 Flows

Swap Shower

Art No.	Thread Size	Length	Breadth	Material	Finish
8570	15mm (1/2")	250mm(10")	185mm(7.4")	ABS	Polished CP

Enjoy the Rain of Water Fall in one shower with Viking Swap Shower

SWITCH MODES BY PRESSING BUTTONS

CASCADE FLOW

RAIN SHOWER

8570



Body Jet

Art No.	Thread Size	Length	Breadth	Height	Material	Finish
8475	15mm (1/2")	120mm(4.8")	185mm(7.4")	32mm(1-1/4")	SS 304	Polished



Rain Shower-Rectangular
- Works Without Pressure Pump

Art No.	Thread Size	Length	Breadth	Material	Finish
8600	75mm(3")	75mm(3")	150mm(6")	ABS	Polished CP



Rain Shower-Square

Art No.	Thread Size	Length	Breadth	Material	Finish
8601	150mm(6")	150mm(6")	150mm(6")	ABS	Polished CP



Rain Shower-Square
- Works Without Pressure Pump

Art No.	Length	Breadth	Material	Finish
8601A	100mm(4")	100mm(4")	ABS	Polished CP
8601A.51 (Ball joint Connector Kit (replacement) for Shower)				
Fits with 8600, 8601 A, 8604, 8615, 8616, 8617, 8630, 8632				



Rain Shower-Square

Art No.	Length	Breadth	Material	Finish
8602	175mm(7")	175mm(7")	ABS	Polished CP
8604	250mm(10")	250mm(10")	ABS	Polished CP



Rain Shower-Round

Art No.	Dia	Material	Finish
8615	175mm(7")	ABS	Polished CP
8616	200mm(8")	ABS	Polished CP
8617	250mm(10")	ABS	Polished CP



Rain Shower-Oval

Art No.	Dia	Material	Finish
8630	200mm(8")	ABS	Polished CP
8632	250mm(10")	ABS	Polished CP



Rain Shower Arm

Art No.	Thread Size 1	Thread Size 2	Length	Material	Finish
8701	15mm (1/2")	15mm (1/2")	225mm(9")	Brass	Polished CP
8702	15mm (1/2")	15mm (1/2")	300mm(12")	Brass	Polished CP
8703	15mm (1/2")	15mm (1/2")	375mm(15")	Brass	Polished CP
8704	15mm (1/2")	15mm (1/2")	450mm(18")	Brass	Polished CP
8706	15mm (1/2")	15mm (1/2")	600mm(24")	Brass	Polished CP



Shower Arm Square

Art No.	Thread Size 1	Thread Size 2	Length	Material	Finish
8762	15mm (1/2")	15mm (1/2")	300mm(12")	Brass	Polished CP
8763	15mm (1/2")	15mm (1/2")	375mm(15")	Brass	Polished CP
8764	15mm (1/2")	15mm (1/2")	450mm(18")	Brass	Polished CP
8766	15mm (1/2")	15mm (1/2")	600mm(24")	Brass	Polished CP



Shower Arm Rectangular

Art No.	Thread Size 1	Thread Size 2	Length	Material	Finish
8781	15mm (1/2")	15mm (1/2")	225mm(9")	Brass	Polished CP
8782	15mm (1/2")	15mm (1/2")	300mm(12")	Brass	Polished CP
8783	15mm (1/2")	15mm (1/2")	375mm(15")	Brass	Polished CP
8784	15mm (1/2")	15mm (1/2")	450mm(18")	Brass	Polished CP
8785	15mm (1/2")	15mm (1/2")	600mm(24")	Brass	Polished CP



Shower Arm Classic

Art No.	Thread Size 1	Thread Size 2	Length	Material	Finish
8805	15mm (1/2")	15mm (1/2")	170mm(6.3/4")	Brass	Polished CP

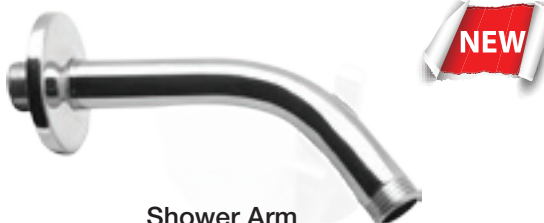

Shower Arm

Art No.	Thread Size 1	Thread Size 2	Material	Finish
8810	15mm (1/2")	15mm (1/2")	Brass	Polished CP
8813	15mm (1/2")	15mm (1/2")	SS 304	Polished



Shower Arm Sleek

Art No.	Thread Size 1	Thread Size 2	Length	Material	Finish
8815	15mm (1/2")	15mm (1/2")	200mm(8")	Brass	Polished CP



Shower Arm S Shape

Art No.	Thread Size 1	Thread Size 2	Material	Finish
8875	15mm (1/2")	15mm (1/2")	Brass	Polished CP



Ceiling Shower Arm-With Flange Round

Art No.	Thread Size 1	Thread Size 2	Length	Material	Finish
8884	15mm (1/2")	15mm (1/2")	75mm (3")	Brass	Polished CP
8886	15mm (1/2")	15mm (1/2")	150mm(6")	Brass	Polished CP
8888	15mm (1/2")	15mm (1/2")	225mm(9")	Brass	Polished CP
8890	15mm (1/2")	15mm (1/2")	300mm(12")	Brass	Polished CP
8891	15mm (1/2")	15mm (1/2")	375mm(15")	Brass	Polished CP
8892	15mm (1/2")	15mm (1/2")	450mm(18")	Brass	Polished CP
8894	15mm (1/2")	15mm (1/2")	600mm(24")	Brass	Polished CP



Ceiling Shower Arm-Square

Art No.	Thread Size 1	Thread Size 2	Length	Material	Finish
8898	15mm (1/2")	15mm (1/2")	75mm (3")	Brass	Polished CP
8899	15mm (1/2")	15mm (1/2")	125mm(5")	Brass	Polished CP
8900	15mm (1/2")	15mm (1/2")	225mm(9")	Brass	Polished CP
8902	15mm (1/2")	15mm (1/2")	300mm(12")	Brass	Polished CP
8903	15mm (1/2")	15mm (1/2")	375mm(15")	Brass	Polished CP
8904	15mm (1/2")	15mm (1/2")	450mm(18")	Brass	Polished CP



Rack Bolt Screw-Pair

Art No.	Thread Size	Length	Finish
9490	12mm(1/2")	160mm(6-1/4")	Nickle Plated
9491	12mm(1/2")	225mm(9")	Nickle Plated
9490.02 (Brass Washer-Pack of 6)			Brass
9490.03 (Brass Nut 1/2"-Pack of 2)			Brass
9490.04 (Rubber Washer-Pack of 12)			Black
9490.05 (Escalate Bracket-Pack of 2)			Zinc Plated
9490.06 (Dowel-Pack of 6)			Grey
9490.10 (Flanged Bush-Pack of 6)			



Rack Bolt Screw - Pair

Art No.	Thread Size	Length	Finish
9495	12mm(1/2")	160mm(6-1/4")	Nickle Plated



Rack Bolt Screw-Pair

Art No.	Thread Size	Length	Finish
9501	16mm(5/8")	160mm(6-1/4")	Steel
9502	16mm(5/8")	225mm(9")	Nickle Plated
9501.02 (Metal Cap CP-Pack of 2)			Polished CP



Rack Bolt Screw - Pair (With ABS Cap)

Art No.	Thread Size	Length	Finish
9505	16mm(5/8")	160mm(6-1/4")	Nickle Plated
9505.03 (Cap CP ABS-Pack of 2)			Polished CP
9505.04 (Nut Brass-Pack of 2)			Brass
9505.05 (Washer Brass-Pack of 6)			Brass
9505.06 (Bush Rubber Taper-Pack of 6)			Black
9505.07 (Dowel-Pack of 6)			Grey



Rack Bolt Screw- Pair (With ABS Cap)

Art No.	Thread Size	Length	Finish
9507	16mm(5/8")	160mm(6-1/4")	Nickle Plated
9508	16mm(5/8")	225mm(9")	Nickle Plated

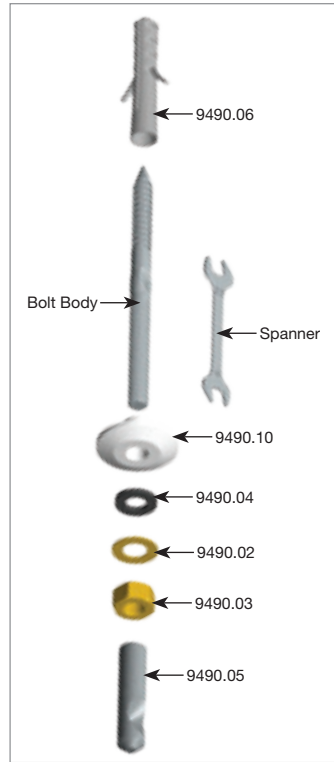

Breakup view of 9490 parts



Rack Bolt Screw-Pair

Art No.	Thread Size	Length	Finish
9498	12mm(1/2")	160mm(6-1/4")	Nickle Plated



Breakup view of 9505 parts



Rack Bolt Brass-Pair

Art No.	Thread Size	Length	Finish
9511	16mm(5/8")	160mm(6-1/4")	Brass
9513	16mm(5/8")	225mm(9")	Brass
9515	16mm(5/8")	300mm(12")	Brass



Rack Bolt SS 304-Pair

Art No.	Thread Size	Length	Finish
9521	16mm(5/8")	160mm(6-1/4")	Steel
9523	16mm(5/8")	225mm(9")	Steel



Rack Bolt-Pair

Art No.	Thread Size	Length	Finish
9525	16mm(5/8")	175mm(7")	CP



Bolt-Pair

Art No.	Thread Size	Length	Finish
9551	10mm(3/8")	70mm(2-3/4")	Polished



Rack Bolt Screw-Pair

Art No.	Thread Size	Length	Finish
9601	10mm(3/8")	120mm(4-3/4")	CP
9601.10 Cap CP			Polished CP



Rack Bolt Screw-Pair

Art No.	Thread Size	Length	Finish
9609	10mm(3/8")	115mm(4-1/2")	CP
9609.03 Rubber Washer	10mm-Pack of 12		Brass
9609.04 Brass Washer	10mm-Pack of 6		Brass
9609.05 Dowel	10mm-Pack of 6		Grey
9609.06 Nut Brass	10mm-Pack of 6		Brass
9609.07 Knob for Rack bolt	10mm-Pack of 6		White



Rack Bolt Screw-Pair

Art No.	Thread Size	Length	Finish
9615	10mm(3/8")	115mm(4-1/2")	CP
9618	10mm(3/8")	140mm	CP



Screw For EWC With Show Flange-Pair

Art No.	Length	Finish
9951	75mm(3")	Brass
9961	100mm(4")	Brass

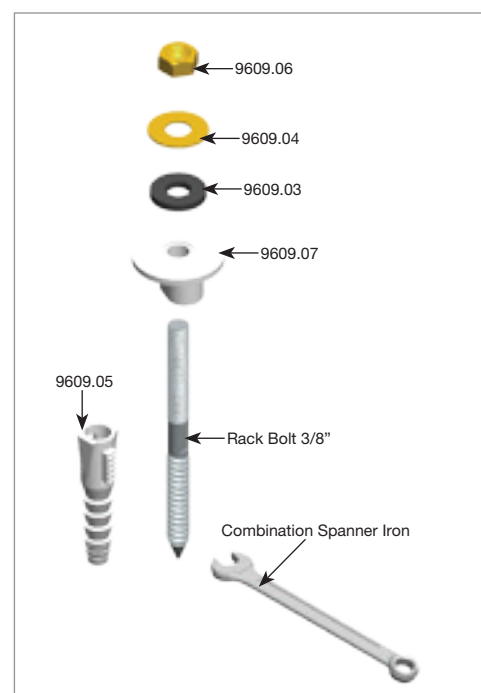

Breakup view of 9609 parts



Hinges For Seat Cover-Pair, Hinges Long Thread-Pair

Art No.	Thread Size	Material	Finish
9991	8mm	Brass	Polished CP
9995	8mm	Brass	Polished CP



Short & Long Bend

Art No.	Material	Finish
10301 Short Bend	SS 201	Polished
10305 Long Bend	SS 201	Polished



Pillar Cock Touch On-Touch Off (Swan Neck)
(Fits all counter top basins)

Art No.	Thread Size	Material	Finish
10610	15mm(1/2")	Brass	Polished CP

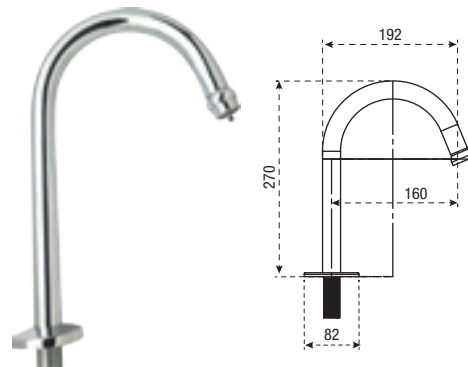

Pillar Cock Touch On-Touch Off (Swan Neck)
(Fits all counter top basins)

Art No.	Thread Size	Material	Finish
10611	15mm(1/2")	Brass	Polished CP

PATENT TECHNOLOGY

ART NO. 10610 & 10611

12"

single touch tap

7 YEARS WARRANTY

THE TAP A KID CAN OPERATE

HYGIENIC TO USE



Bib Cock Touch On-Touch Off

Art No.	Thread Size	Material	Finish
10615	15mm (1/2")	Brass	Polished CP



Aerator Touch On-Touch Off

Art No.	Material	Finish
10625	Brass	Polished CP

PATENTED TECHNOLOGY

touch on
touch off
aerator

A Tap a Kid in kindergarden can operate

ONE TOUCH AERATOR

HOW TO CONVERT YOUR TAP TO TOUCH TAP

REMOVE OLD AERATOR & FIX ONE TOUCH AERATOR

ADJUST HOT & COLD WATER TEMP. AS PER YOUR NEED

TOUCH TO ON

DESIRED TEMP. OF WATER IS RELEASE

TOUCH TO OFF

OFF POSITION

- NO MAINTENANCE
- NO BATTERY OR CURRENT REQUIRED
- FLOW RATE 8.3 LITRE / MIN

HYGIENIC TO USE

REGULAR TAP

DIRTY TAP HANDLE SOIL YOUR HANDS AGAIN

Turning on Taps with Soiled Hands

DIRT STILL REMAIN ON HANDLE

Dirt Washed Away with water

Clean Tap Clean Hands



Pillar Cock Tri

Art No.	Thread Size	Material	Finish
10705	15mm (1/2")	Brass	Polished CP



Bib Cock Short Body Tri

Art No.	Thread Size	Material	Finish
10710	15mm (1/2")	Brass	Polished CP



Bib Cock Long Body Tri

Art No.	Thread Size	Material	Finish
10715	15mm (1/2")	Brass	Polished CP



Concealed Stop Cock Tri

Art No.	Thread Size	Material	Finish
10720	15mm (1/2")	Brass	Polished CP
10721	20mm(3/4")	Brass	Polished CP
10721.51 (Flange Assembly for 10721, 5765)		Brass	Polished CP



Spout With Flange

Art No.	Thread Size	Material	Finish
10724	15mm (1/2")	Brass	Polished CP
24132 (Hex Nipple)			
10724.04 (Flange)		Brass	Polished CP



Angle Cock Tri

Art No.	Thread Size	Material	Finish
10727	15mm (1/2")	Brass	Polished CP



Nozzle Cock Tri

Art No.	Thread Size	Material	Finish
10730	15mm (1/2")	Brass	Polished CP



Aerator Foam Flow (Inner)

Art No.	Thread Size	Material	Finish
10738	F22 X 1	Brass	Polished CP



Aerator Foam Flow (Outer)

Art No.	Thread Size	Material	Finish
10739	M24 X 1	Brass	Polished CP



Coin Slot Aerator

Art No.	Thread Size	Material	Colour
10740	M24 X 1	Plastic (Food Grade)	Grey



Aerator (For Mixtures & Spout)

Art No.	Thread Size	Material	Finish
10741	M28 X 1	Brass	Polished CP



Bib Tap For Washing Machine

Art No.	Thread Size	Material	Finish
10742	15mm (1/2")	Brass	Polished CP



Bib Cock Two Way

Art No.	Thread Size	Material	Finish
10745	15mm (1/2")	Brass	Polished CP



Angle Cock Two Way

Art No.	Thread Size	Material	Finish
10750	15mm (1/2")	Brass	Polished CP



Tap For Washing Machine

Art No.	Thread Size	Material	Finish
10870	15mm (1/2")	Brass	Polished CP



Extension Nipple With Valve
- Low Cost Angle Valve

Art No.	Thread Size	Material	Finish
10880	15mm (1/2")	Brass	Polished CP

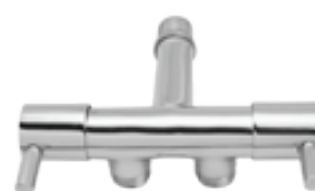

Angle Cock - 2 Way
- 1st Outlet for Gyser other for Solar Heater.

Art No.	Thread Size 1	Type	Thread Size 2	Type	Material	Finish
10888	15mm (1/2")	Outer	15mm (1/2")	Outer	Brass	Polished CP





Angle Cock (Filter Inside)
- Filtered Water.

Art No.	Thread Size 1	Thread Size 2	Material	Finish
10900	15mm(1/2")	15mm(1/2")	Brass	Polished CP



Angle Cock Filter (Filter Inside)
- Filtered Water.
- Water for Tooth Brushing will be clean.

Art No.	Thread Size	Material	Finish
10901	15mm (1/2")	Brass	Polished CP



Angle Cock-Bullet (Disc)

Art No.	Thread Size	Material	Finish
10903	15mm (1/2")	Brass	Polished CP



Angle Cock-Oval

Art No.	Thread Size	Material	Finish
10910	15mm (1/2")	Brass	Polished CP



Angle Cock-Square

Art No.	Thread Size	Material	Finish
10921	15mm (1/2")	Brass	Polished CP



Angel Valve-Turbo

Art No.	Thread Size 1	Thread Size 2	Material	Finish
10925	15mm (1/2")	15mm(1/2")	Brass	Polished CP



Angle Cock-Disc

Art No.	Thread Size	Material	Finish
10930	15mm (1/2")	Brass	Polished CP



Angle Cock-Octa

Art No.	Thread Size	Material	Finish
10938	15mm (1/2")	Brass	Polished CP



Multi Purpose Valve

Art No.	Thread Size	Material	Finish
10945	15mm (1/2")	Brass	CP



Nozzle Cock

Art No.	Thread Size	Material	Finish
11001	15mm (1/2")	Brass	Polished CP
11003	20mm(3/4")	Brass	Polished CP



Nozzle Cock - Fixed Nozzle

Art No.	Thread Size	Material	Finish
11005	15mm (1/2")	Brass	Polished CP
11007	20mm (1/2")	Brass	Polished CP



Angle Cock

Art No.	Thread Size	Material	Finish
11009	15mm (1/2")	Brass	Polished CP



Bib Cock

Art No.	Thread Size	Material	Finish
11010 Small	15mm (1/2")	Brass	Polished CP
11015 Big	15mm (1/2")	Brass	Polished CP
11016 Large	20mm(3/4")	Brass	Polished CP



Stop Cock Small

Art No.	Thread Size	Material	Finish
11025	15mm (1/2")	Brass	Polished CP



Taper Cock

Art No.	Thread Size	Material	Finish
11060	15mm (1/2")	Brass	Polished CP



Conversion Bend

Art No.	Thread Size	Material	Finish
11084	20mm(3/4")	Brass	Polished CP



Crutch

Art No.	Material	Finish
11090 Single	Brass	Polished CP
11092 Double	Brass	Polished CP



Wall Mixture Legs-Pair

Art No.	Thread Size	Material	Finish
11105	20mm(3/4")	Brass	Brass



Live the royal

with viking Antique Finishing Garden Faucet

Give your Garden tap the Garden look with Sparrow head Garden faucet.



Garden Faucet

Art No.	Thread Size	Type	Material	Finish
11515	15mm (1/2")	Outer	Brass	Antique Brass

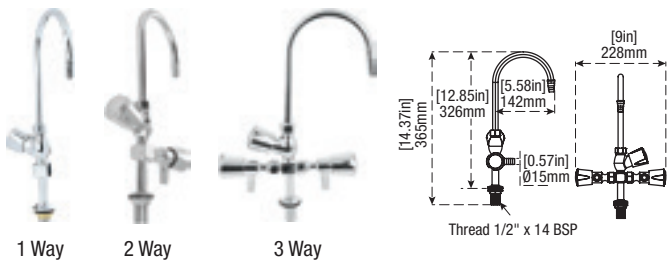

Lab Cock

Art No.	Thread Size	Type	Material	Finish
11611 (1 Way)	15mm (1/2")	Outer	Brass	Polished CP
11611.50 (Spout Assembly with Nut & O-Ring)			Brass	Polished CP
11612 (2 Way)	15mm (1/2")	Outer	Brass	Polished CP
11613 (3 Way)	15mm (1/2")	Outer	Brass	Polished CP

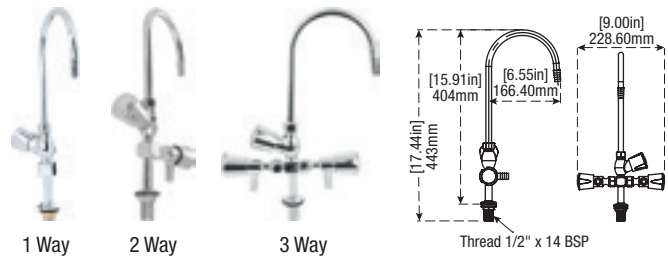

**Lab Cock-Extended Spout
(Spout Size 166mm)**

Art No.	Thread Size	Type	Material	Finish
11615	15mm (1/2")	Outer	Brass	Polished CP
11616	15mm (1/2")	Outer	Brass	Polished CP
11617	15mm (1/2")	Outer	Brass	Polished CP



Lab Cock

Art No.	Type	Material	Finish
11621 (1 Way)	Outer	Brass	Powder Coated
11623 (2 Way)	Outer	Brass	Powder Coated
11625 (3 Way)	Outer	Brass	Powder Coated



Water Filter Valve



Water Filter Cock

Art No.	Thread Size	Type	Thread Size 2	Type	Material	Finish
11650	15mm (1/2")	Outer	15mm (1/2")	Inner	Brass	Polished CP

Art No.	Thread Size	Material	Finish
11651	15mm (1/2")	Brass	Polished CP



11750



Pillar Tap - Self Closing Time Delayed

Art No.	Thread Size	Type	Material	Finish
11800	15mm(1/2")	Outer	Brass	Polished CP



Push Cock

Art No.	Thread Size	Type	Material	Finish
11832	15mm (1/2")	Outer	Brass	Polished CP



Lift Cock

Art No.	Thread Size	Material	Finish
11871	15mm (1/2")	Brass	Polished CP
11872	20mm(3/4")	Brass	Polished CP



Outlet Tube

Art No.	Thread Size	Type	Material	Finish
11899	15mm (1/2")		Brass	Polished CP



Faucet Drinking Water Fountain

Art No.	Thread Size	Type	Material	Finish
11750	6.35mm(1/4")	Outer	Brass	Polished CP



Push Cock

Art No.	Thread Size	Type	Material	Finish
11812	15mm(1/2")	Outer	Brass	Polished CP



**Push Cock
-Self Closing**

Art No.	Thread Size	Type	Material	Finish
11834	15mm (1/2")	Outer	Brass	Polished CP



Push Cock Connector

Art No.	Thread Size	Type	Material	Finish
11898	15mm (1/2")	Outer	Brass	Polished CP



Nozzle For Foam Flow Bib Cock

Art No.	Thread Size	Material	Finish
12105	M24X1	Brass	Polished CP
12106	M22X1	Brass	Polished CP



Push Cock

Art No.	Thread Size	Type	Material	Finish
11851	15mm (1/2")	Inner	Brass	Polished CP
11852	20mm(3/4")		Brass	Polished
11855	Replacment Kit for Push N Urinal Valve 11851, 52, 6232, 33			



Nozzle For Washing Machine

Art No.	Thread Size 1	Material	Finish
12205	15mm (1/2")	Brass	CP
12208	20mm(3/4")	Brass	CP

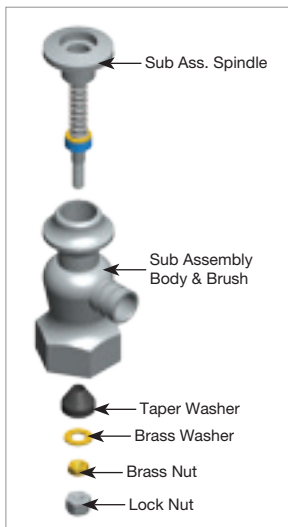

Breakup view of 11851 parts



P.T.F.E Thread Seal Tape

Art No.	Length	Breadth	Height	Material	Colour
12512	10mtr	12mm(1/2")	0.10mm	PTFE (Polytetrafluoroethylene)	Yellow
12514	30mtr	12mm(1/2")	0.10mm	PTFE (Polytetrafluoroethylene)	Yellow
12534	10mtr	19mm(3/4")	0.10mm	PTFE (Polytetrafluoroethylene)	Yellow
12536	30mtr	19mm(3/4")	0.10mm	PTFE (Polytetrafluoroethylene)	Yellow
12550	10mtr	25mm(1")	0.10mm	PTFE (Polytetrafluoroethylene)	Yellow

What is Thread Seal Tape :

Thread Seal Tape (Teflon Tape) is a common inexpensive and effective thin yellow tape used to seal pipe threads being joined together for plumbing purposes. It is used to seal water, from leaking through threaded connections.

THREAD SEAL TAPE VS DIAGRAM

AN EXPERT PLUMBER USES THREAD SEAL TAPE TO SEAL PIPE JOINTS. THREAD SEAL TAPE COVERS FIRST PIPE THREADS AND FILLING GAPS BETWEEN THREADS. (SEE DIAGRAM)

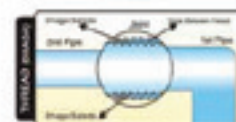

WHY THREAD SEAL TAPE USE :

THREAD SEAL TAPE COVER ALL THREAD FILLING THE GAP BETWEEN THREAD TO THREAD MINIMIZING CHANCES OF LEAKAGE (SEE DIAGRAM)

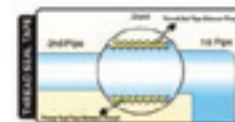

TILE LEVELLING SYSTEM



WHY DO WE NEED IT

- To Avoid Lippage¹
- Tiles / Marble /Stone need Perfect workmanship
- Unskilled labour
- Dust Dirt Water stands/ stuck around lippage (Unhygienic)

Notes:

1. “Lippage” : Different heights of adjoining tiles is called Lippage.

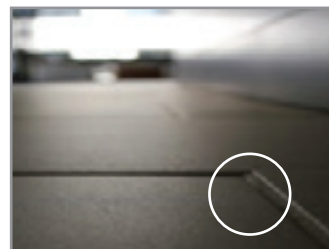
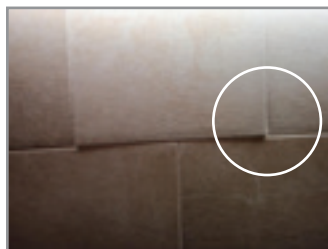
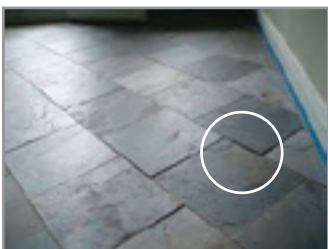

HOW TO USE IT



1

Apply Tile Glue / Cement

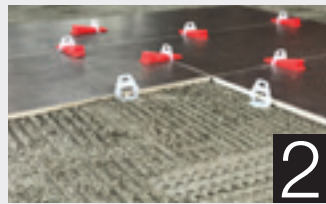

2

Tile Spacer below the one Tile

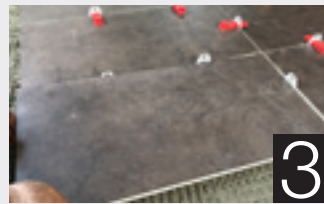

3

Place the other Tile over the other end of Tile Spacer



4

Insert Wedge into the Tile Spacer



5

Tighten Wedge using our Special Tool-Plier

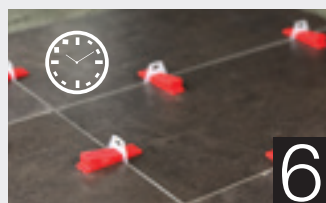

6

Let adhesive (Tile Glue / Cement) dry as recommended.

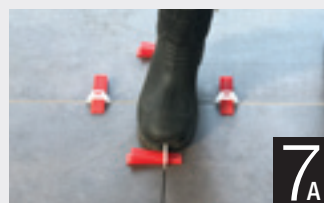

7A

Simply Remove Wedges with a kick



7B

Or simply Remove Wedges with a Mallet



Tile Spacer

Art No.	Height	Colour
12572 (100 Pcs /Pkt)	2mm	White
12573 (100Pcs /Pkt)	3mm	White
12574 (100 Pcs /Pkt)	4mm	White
12575 (100 Pcs /Pkt)	5mm	White
12578 (100 Pcs /Pkt)	8mm	White



Plier-Tile Levelling



Art No.	Material	Finish
12635	Mild Steel	Zinc Plated



Wedge



Art No.	Material	Colour
12640	PPCP	Red



Clip-Tile Levelling & Spacer



Art No.	Size	Material	Colour
12642	2mm	PPCP	Translucent
12643	3mm	PPCP	Translucent
12644	4mm	PPCP	Translucent

BRASS CP FLANGES



Flange-Threaded

Art No.	Thread Size	Material	Dia	Finish
12703	15mm (1/2")	Brass		Polished CP



Flange Regular-Flat

Art No.	Thread Size	Material	Dia	Finish
12705	15mm (1/2")	Brass	67mm	Polished CP



Flange-Slanting Dome

Art No.	Thread Size	Material	Dia	Finish
12708	15mm (1/2")	Brass	55mm	Polished CP



Flange-Flora

Art No.	Thread Size	Material	Dia	Finish
12712	15mm (1/2")	Brass	70mm	Polished CP

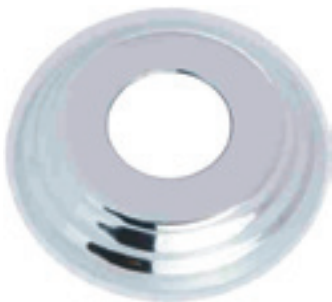

Flange-Zig Zag

Art No.	Thread Size	Material	Dia	Finish
12722	15mm (1/2")	Brass	51mm	Polished CP



Flange-Square

Art No.	Thread Size	Length	Breadth	Material	Finish
12730	15mm (1/2")	60mm	60mm	Brass	Polished CP

SS FLANGES

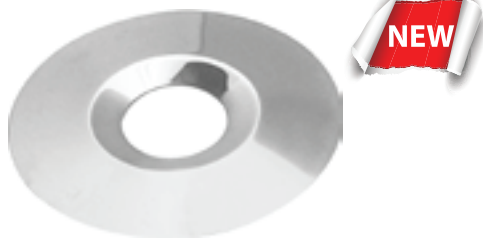

Flange

Art No.	Thread Size	Material	Dia	Finish
12775	15mm (1/2")	SS 304	68mm	Polished



Flange-Grip on Thread

Art No.	Thread Size	Material	Dia	Finish
12885	15mm (1/2")	SS 304	58mm	Polished



Flange-Ocular

Art No.	Thread Size	Material	Dia	Finish
12902	15mm (1/2")	SS 201	70mm	Polished



Flange-Sleek

Art No.	Thread Size	Material	Dia	Finish
12912	15mm (1/2")	SS 201	65mm	Brushed



Flange-Flat

Art No.	Thread Size	Material	Dia	Finish
12914	15mm (1/2")	SS 201	68mm	Brushed



Flange-Square

Art No.	Thread Size	Length	Breadth	Material	Finish
12917	15mm (1/2")	60mm	60mm	SS 430	Polished



Flange-Florantine

Art No.	Thread Size	Material	Dia	Finish
12920	15mm (1/2")	SS 201	70mm	Brushed
12921	20mm (3/4")	SS 201	70mm	Polished



Flange-Big OD

Art No.	Thread Size	Material	Dia	Finish
12930	15mm (1/2")	SS 201	73mm	Polished
12932	32mm (1-1/4")	SS 201	73mm	Polished



Full Thread Nipple

Art No.	Thread Size	Type	Length	Material	Finish
13721	15mm (1/2")	Outer	57mm (2-1/4")	Brass	CP
13722	20mm (3/4")	Outer	57mm (2-1/4")	Brass	CP



Running Nipple

Art No.	Thread Size 1	Type	Thread Size 2	Type	Length	Material	Finish
13742	20mm (3/4")	Outer	15mm (1/2")	Inner	25mm (1")	Brass	CP
13744	20mm (3/4")	Outer	15mm (1/2")	Inner	50mm (2")	Brass	CP
13745	20mm (3/4")	Outer	15mm (1/2")	Inner	75mm (3")	Brass	CP
13747	32mm (1-1/4")	Outer	25mm (1")	Inner	50mm (2")	Brass	CP
13760	25mm(1")				100mm(4")	Brass	CP



Full Thread Nipple For Flush Valve

Art No.	Thread Size	Type	Length	Material	Finish
13765	32mm (1-1/4")	Outer	65mm(2-1/2")	Brass	CP
13775	32mm (1-1/4")	Outer	100mm(4")	Brass	CP
13785	32mm (1-1/4")	Outer	150mm(6")	Brass	CP
13788	40mm(1-1/2")	Outer	100mm(4")	Brass	CP



Line Strainer-Italia

Art No.	Thread Size 1	Type	Thread Size 2	Type	Material	Finish
14026	25mm (1")	Inner	25mm (1")	Inner	Brass	CP
14027	32mm (1 1/4")	Inner	32mm (1-1/4")	Inner	Brass	CP
14028	40mm (1-1/2")	Inner	40mm (1-1/2")	Inner	Brass	CP
14029	50mm (2")	Inner	50mm (2")	Inner	Brass	CP

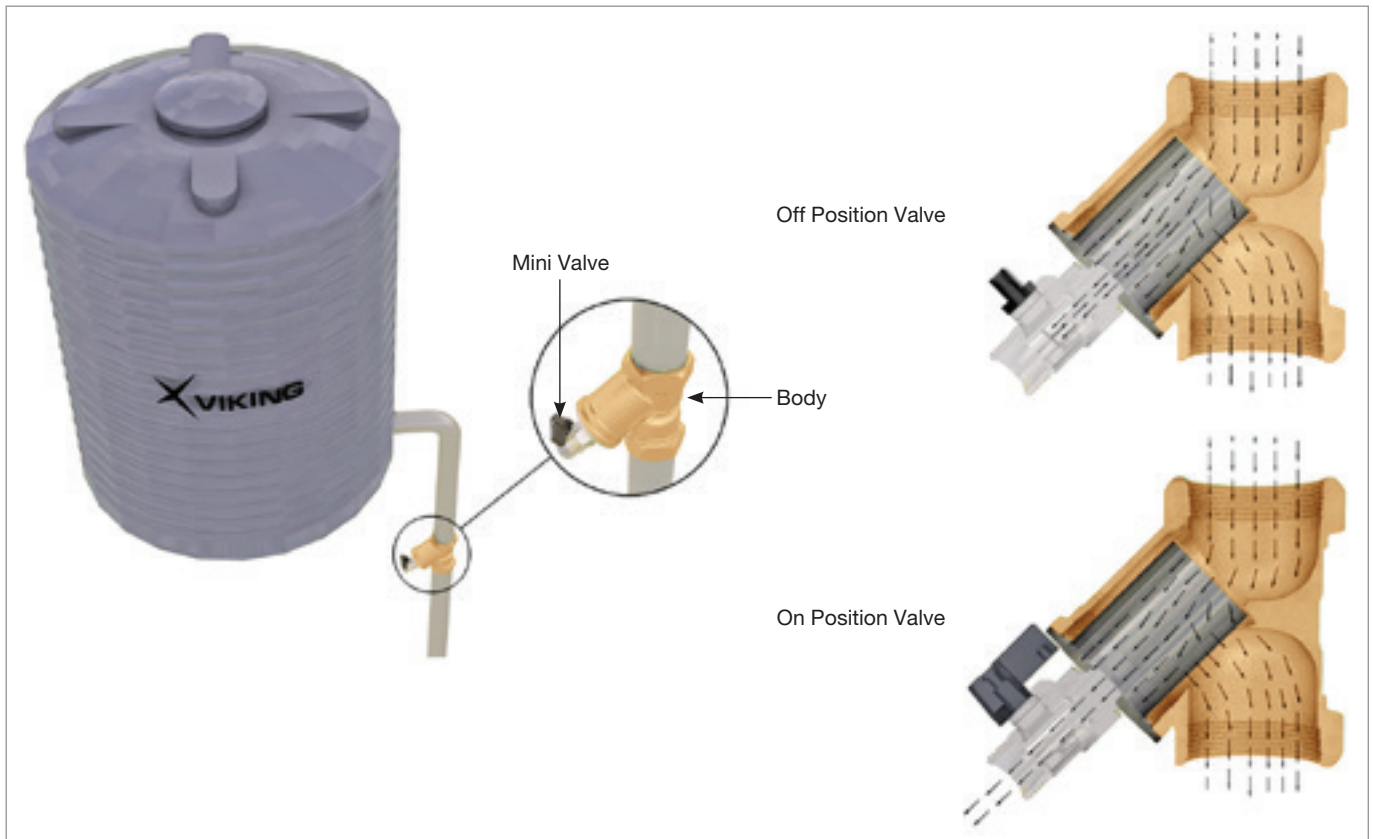

When Construction Start dust or bad particles enter the tank, these particles choke nozzle of;

- Shower
- Health Faucets
- Water Filters (RO) and other plumbing fixtures.
- For better hygienic & long life use viking line strainer.



Float Valve With Flexible Rod-Brass

Art No.	Thread Size	Type	Length	Material	Finish
14101	15mm (1/2")	Outer	225mm(9")	Brass	Brass
14102	20mm (3/4")	Outer	225mm(9")	Brass	Brass
14103	25mm (1")	Outer	300mm(12")	Brass	Brass
14104	32mm (1-1/4")	Outer	300mm(12")	Brass	Brass
14105	40mm (1-1/2")	Outer	375mm(15")	Brass	Brass
14106	50mm (2")	Outer	450mm(18")	Brass	Brass

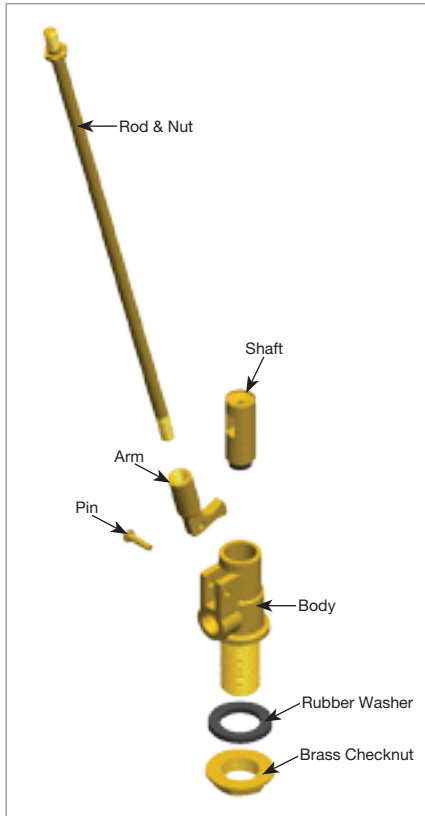

Breakup view of 14101 parts

Size	Rod & Nut	Rubber Washer	Brass Checknut
15mm (1/2")	14101.51	14101.12 (Pack of 15)	14101.06 (Pack of 5)
20mm (3/4")	14101.51	14102.07 (Pack of 10)	14102.06 (Pack of 5)
25mm (1")	14103.51	14103.12 (Pack of 5)	14103.07 (Pack of 2)
32mm (1-1/4")	14104.51	5313.04 (Pack of 5)	5313.05
40mm (1-1/2")	14104.51	5333.04 (Pack of 5)	5333.05
50mm (2")	14106.51	5365.02 (Pack of 2)	5365.03



PVC Float Ball White-First Grade

Art No.	Suitable	Material	Dia	Colour
14209	15mm (1/2"), 20mm(3/4")	PVC	100mm(4")	White
14219	25mm(1")	PVC	150mm(6")	White
14229	32mm(1-1/4") 40mm(1-1/2") 50mm(2")	PVC	225mm(9")	White
14232	15mm (1/2") (Small for Cooler)	PVC		White



Copper Float Ball

Art No.	Suitable	Material	Dia	Colour
14240	15mm (1/2")	Copper	100mm(4")	Black
14241	15mm (1/2")	Copper	150mm(6")	Copper
14242	15mm (1/2")	Copper	200mm(8")	Copper
14243	15mm (1/2")	Copper	250mm(10")	Brass



Ball Valve Full way Half Turn

Art No.	Thread Size	Type	Material	Finish
15101	15mm (1/2")	Inner	Brass	Brass
15102	20mm (3/4")	Inner	Brass	Brass
15103	25mm (1")	Inner	Brass	Brass
15104	32mm (1-1/4")	Inner	Brass	Brass
15105	40mm (1-1/2")	Inner	Brass	Brass
15106	50mm (2")	Inner	Brass	Brass
15107	62.5mm (2.5")	Inner	Brass	Brass
15112	100mm(4")	Inner	Brass	Brass



Pressure Reducing Valve

Art No.	Thread Size	Material	Finish
16110	15mm(1/2")	Brass	Nickle Plated
16112	20mm (3/4")	Brass	Nickle Plated
16114	25mm (1")	Brass	Nickle Plated



Foot Valve

Art No.	Thread Size	Type	Material	Finish
18302	20mm (3/4")	Inner	Brass	Brass
18303	25mm (1")	Inner	Brass	Brass
18304	32mm (1-1/4")	Inner	Brass	Brass
18305	40mm (1-1/2")	Inner	Brass	Brass
18306	50mm (2")	Inner	Brass	Brass



Foot Valve - With SS Mesh

Art No.	Thread Size	Type	Material	Finish
18310	15mm(1/2")	Inner	Brass	Brass
18312	20mm (3/4")	Inner	Brass	Brass
18314	25mm (1")	Inner	Brass	Brass
18316	32mm (11/4")	Inner	Brass	Brass
18318	40mm(1-1/2")	Inner	Brass	Brass
18320	50mm (2")	Inner	Brass	Brass



Check Valve - Swing Type

Art No.	Thread Size	Type	Material	Finish
18424	15mm(1/2")	Inner	Brass	Brass Shot Blasted
18425	20mm (3/4")	Inner	Brass	Brass Shot Blasted
18426	25mm (1")	Inner	Brass	Brass Shot Blasted
18427	32mm (11/4")	Inner	Brass	Brass Shot Blasted
18428	40mm(1-1/2")	Inner	Brass	Brass Shot Blasted
18429	50mm (2")	Inner	Brass	Brass Shot Blasted



Check Valve-Vertical (Non Return Valve)

Art No.	Thread Size	Type	Material	Finish
18501	15mm(1/2")	Inner	Brass	Shot Blasted CP
18502	20mm (3/4")	Inner	Brass	Shot Blasted CP
18503	25mm (1")	Inner	Brass	Shot Blasted CP



Check Valve

Art No.	Thread Size 1	Type	Thread Size 2	Type	Material	Finish
18510	15mm(1/2")	Inner	15mm(1/2")	Inner	Brass	Brass Shot Blasted
18512	20mm (3/4")	Inner	20mm (3/4")	Inner	Brass	Brass Shot Blasted
18514	25mm (1")	Inner	25mm (1")	Inner	Brass	Brass Shot Blasted
18516	32mm (11/4")	Inner	32mm (11/4")	Inner	Brass	Brass Shot Blasted
18518	40mm(1-1/2")	Inner	40mm(1-1/2")	Inner	Brass	Brass Shot Blasted
18520	50mm(2")	Inner	50mm(2")	Inner	Brass	Brass Shot Blasted



Air Vent Filter

Art No.	Thread Size	Type	Material	Finish
18580	15mm(1/2")	Outer	SS 304	Steel
18582	20mm (3/4")	Outer	SS 304	Steel
18584	25mm (1")	Outer	SS 304	Steel
18586	32mm (11/4")	Outer	SS 304	Steel
18588	40mm(1-1/2")	Outer	SS 304	Steel
18590	50mm (2")	Outer	SS 304	Steel



Relief Valve
- Used in Air Compressor

Art No.	Thread Size	Type	Material	Finish
18703	15mm(1/2")	Outer	Brass	Polished CP
18713	15mm(1/2")	Inner	Brass	Polished CP



Pig can drink when feel

Pig Tap

Art No.	Thread Size	Type	Material	Finish
19800	15mm(1/2")	Outer	SS 304	Brushed





Extension Nipple

Art No.	Thread Size 1	Type	Thread Size 2	Type	Length	Material	Finish
22006	10mm(3/8")	Inner	10mm(3/8")	Outer	100mm(4")	Brass	Polished CP
22007	10mm(3/8")	Inner	10mm(3/8")	Outer	150mm(6")	Brass	Polished CP



Extension Nipple

Art No.	Thread Size 1	Type	Thread Size 2	Type	Length	Material	Finish	Allen Key
22011	15mm(1/2")	Inner	15mm(1/2")	Outer	25mm(1')	Brass	Polished CP	×
22011 A	15mm(1/2")	Inner	15mm(1/2")	Outer	25mm(1')	Brass	Polished CP	✓
22012	15mm(1/2")	Inner	15mm(1/2")	Outer	40mm(1-1/2")	Brass	Polished CP	×
22012 A	15mm(1/2")	Inner	15mm(1/2")	Outer	40mm(1-1/2")	Brass	Polished CP	✓
22013	15mm(1/2")	Inner	15mm(1/2")	Outer	50mm(2")	Brass	Polished CP	×
22013 A	15mm(1/2")	Inner	15mm(1/2")	Outer	50mm(2")	Brass	Polished CP	✓
22014	15mm(1/2")	Inner	15mm(1/2")	Outer	65mm(2-1/2")	Brass	Polished CP	×
22014 A	15mm(1/2")	Inner	15mm(1/2")	Outer	65mm(2-1/2")	Brass	Polished CP	✓
22015	15mm(1/2")	Inner	15mm(1/2")	Outer	75mm(3")	Brass	Polished CP	×
22015 L	15mm(1/2")	Inner	15mm(1/2")	Outer	75mm(3")	Brass	Polished CP	×
22016	15mm(1/2")	Inner	15mm(1/2")	Outer	100mm(4")	Brass	Polished CP	×
22018	15mm(1/2")	Inner	15mm(1/2")	Outer	150mm(6")	Brass	Polished CP	×
22021	15mm(1/2")	Inner	15mm(1/2")	Outer	225mm(9")	Brass	Polished CP	×
22024	15mm(1/2")	Inner	15mm(1/2")	Outer	300mm(12")	Brass	Polished CP	×
22114	20mm (3/4")	Inner	20mm (3/4")	Outer	65mm(2-1/2")	Brass	Polished CP	×
22135	25mm (1")	Inner	25mm (1")	Outer	100mm(4")	Brass	Polished CP	×
22170	32mm (1-1/4")	Inner	32mm (1-1/4")	Outer	32mm(1-1/4")	Brass	Polished CP	×

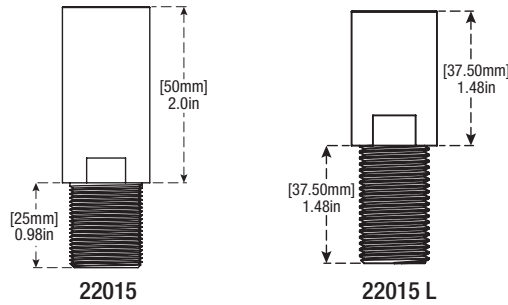

Designed for West Bengal
Both Thread 37mm Long



Extension Nipple With NRV
(Check Valve)

Art No.	Thread Size 1	Type	Thread Size 2	Type	Length	Material	Finish
22185	15mm(1/2")	Inner	15mm(1/2")	Outer	40mm(1-1/2")	Brass	Polished CP



Pipe Nipple

Art No.	Thread Size	Type	Length	Material	Finish
22302	15mm(1/2")	Outer	50mm(2")	Brass	Polished CP
22303	15mm(1/2")	Outer	75mm(3")	Brass	Polished CP
22304	15mm(1/2")	Outer	100mm(4")	Brass	Polished CP
22306	15mm(1/2")	Outer	150mm(6")	Brass	Polished CP
22309	15mm(1/2")	Outer	225mm(9")	Brass	Polished CP
22312	15mm(1/2")	Outer	300mm(12")	Brass	Polished CP
22318	15mm(1/2")	Outer	450mm(18")	Brass	Polished CP
22324	15mm(1/2")	Outer	600mm(24")	Brass	Polished CP
22330	15mm(1/2")	Outer	750mm(30")	Brass	Polished CP
22336	15mm(1/2")	Outer	900mm(36")	Brass	Polished CP
22348	15mm(1/2")	Outer	1200mm(48")	Brass	Polished CP
22353	20mm (3/4")	Outer	75mm(3")	Brass	Polished CP
22354	20mm (3/4")	Outer	100mm(4")	Brass	Polished CP
22356	20mm (3/4")	Outer	150mm(6")	Brass	Polished CP
22359	20mm (3/4")	Outer	225mm(9")	Brass	Polished CP
22365	25mm(1")	Outer	100mm(4")	Brass	Polished CP
22367	25mm(1")	Outer	150mm(6")	Brass	Polished CP
22369	25mm(1")	Outer	225mm(9")	Brass	Polished CP



Elbow

Art No.	Thread Size 1	Type	Thread Size 2	Type	Material	Finish
23105	15mm(1/2")	Inner	15mm(1/2")	Inner	Brass	Polished CP
23106	20mm (3/4")	Inner	20mm(3/4")	Inner	Brass	Polished CP
23110	20mm (3/4")	Inner	15mm(1/2")	Inner	Brass	Polished CP
23114	25mm (1")	Inner	25mm(1")	Inner	Brass	Polished CP
23115	32mm (1-1/4")	Inner	32mm(1-1/4")	Inner	Brass	Polished CP



Elbow

Art No.	Thread Size 1	Type	Thread Size 2	Type	Material	Finish
23231	15mm(1/2")	Inner	15mm(1/2")	Outer	Brass	Polished CP
23232	20mm (3/4")	Inner	15mm(1/2")	Outer	Brass	Polished CP
23234	20mm (3/4")	Inner	20mm(3/4")	Outer	Brass	Polished CP



Elbow

Art No.	Thread Size 1	Type	Thread Size 2	Type	Material	Finish
23242	15mm(1/2")	Outer	15mm(1/2")	Outer	Brass	Polished CP



Tee

Art No.	Thread Size 1	Type	Thread Size 2	Thread Size 3	Material	Finish
23802	15mm(1/2")	Inner	15mm(1/2")	15mm(1/2")	Brass	Polished CP
23804	20mm (3/4")	Inner	20mm (3/4")	20mm (3/4")	Brass	Polished CP
23808	20mm (3/4")	Inner	15mm(1/2")	20mm (3/4")	Brass	Polished CP



Tee-Inner Outer

Art No.	Thread Size	Material	Finish
23812	15mm(1/2")	Brass	Polished CP



Tee Cross Fourway

Art No.	Thread Size 1	Thread Size 2	Thread Size 3	Thread Size 4	Type	Material	Finish
23822	15mm(1/2")	15mm(1/2")	15mm(1/2")	15mm(1/2")	Inner	Brass	Polished CP
23824	20mm(3/4")	20mm(3/4")	20mm(3/4")	20mm(3/4")	Inner	Brass	Polished CP



Socket

Art No.	Thread Size 1	Thread Size 2	Material	Finish
23902	15mm(1/2")	N.A.	Brass	Polished CP
23903	20mm(3/4")	N.A.	Brass	Polished CP
23905	20mm(3/4")	15mm(1/2")	Brass	Polished CP
23907	25mm(1")	N.A.	Brass	Polished CP
23909	32mm(1-1/4")	N.A.	Brass	Polished CP



Hexagonal (Hex) Nipple

Art No.	Thread Size 1	Thread Size 2	Length	Material	Finish
24102	15mm(1/2")	15mm(1/2")	35mm	Brass	CP
24103	20mm (3/4")	20mm (3/4")	38mm	Brass	CP
24104	10mm(3/8")	15mm(1/2")	20mm(3/4")	Brass	CP
24105	20mm(3/4")	15mm(1/2")	38mm	Brass	CP
24106	10mm(3/8")	10mm(3/8")	25mm(1")	Brass	CP
24108	25mm (1")	25mm(1")	40mm	Brass	CP
24109	32mm(1-1/4")	32mm(1-1/4")	68mm	Brass	CP



CP Hexagonal Long Thread

Art No.	Thread Size 1	Thread Size 2	Length	Material	Finish
24129	10mm(3/8")	10mm(3/8")	50mm(2")	Brass	CP
24132	15mm(1/2")	15mm(1/2")	50mm(2")	Brass	CP
24134	20mm(3/4")	15mm(1/2")	65mm(2-1/2")	Brass	CP



Bush

Art No.	Thread Size 1	Thread Size 2	Length	Material	Finish
24202	15mm (1/2")	8mm(1/4")	25mm(1")	Brass	CP
24205	15mm (1/2")	10mm(3/8")	25mm(1")	Brass	CP
24207	20mm(3/4")	15mm (1/2")	25mm(1")	Brass	CP
24208	25mm(1")	20mm(3/4")	25mm(1")	Brass	CP
24209	25mm(1")	15mm (1/2")	25mm(1")	Brass	CP
24210	40mm(1-1/2")	32mm(1-1/4")	32mm(1-1/4")	Brass	CP
24211	20mm(3/4")	15mm (1/2")	40mm(1-1/2")	Brass	CP



CP Plug

Art No.	Thread Size	Material	Finish
24402	15mm (1/2")	Brass	Polished CP
24403	20mm (3/4")	Brass	Polished CP
24405	25mm (1")	Brass	Polished CP



CP Cap Plug

Art No.	Thread Size	Material	Finish
24502	15mm (1/2")	Brass	Polished CP
24503	20mm (3/4")	Brass	Polished CP



CP Union

Art No.	Thread Size	Material	Finish
24802	15mm (1/2")	Brass	Polished CP
24803	20mm (3/4")	Brass	Polished CP



CP Hose Coller Grooved Union Outer End

Art No.	Thread Size	Material	Finish
24902	15mm (1/2")	Brass	Polished CP
24903	20mm (3/4")	Brass	Polished CP



CP Hose Coller Grooved Union Inner End

Art No.	Thread Size	Material	Finish
24922	15mm (1/2")	Brass	Polished CP
24923	20mm (3/4")	Brass	Polished CP



CP Nozzle For Gas Geysers Inner End

Art No.	Thread Size 1	Thread Size 2	Material	Finish
24932	15mm (1/2")	10mm(3/8")	Brass	Polished CP



CP Adapter

Art No.	Thread Size 1	Thread Size 2	Material	Finish
24950	15mm (1/2")	6.35mm(1/4")	Brass	Polished CP
24952	15mm (1/2")	24m For American Fitting	Brass	Polished CP
24955	15mm (1/2")	10mm(3/8")	Brass	Polished CP
24957	20mm (3/4")	15mm(1/2")	Brass	Polished CP



Elbow

Art No.	Thread Size 1	Thread Size 2	Material	Finish
25505	15mm (1/2")	15mm (1/2")	Brass	Brass
25506	20mm (3/4")	20mm (3/4")	Brass	Brass
25510	20mm (3/4")	15mm(1/2")	Brass	Brass
25514	25mm (1")	25mm (1")	Brass	Brass
25515	32mm (1-1/4")	32mm (1-1/4")	Brass	Brass



Tee Fourway - Cross

Art No.	Thread Size	Material	Finish
25622	15mm (1/2")	Brass	Brass
25624	20mm (3/4")	Brass	Brass



Hexagonal Nipple

Art No.	Thread Size 1	Thread Size 2	Material	Finish
25802	15mm (1/2")	15mm (1/2")	Brass	Brass
25803	20mm (3/4")	20mm (3/4")	Brass	Brass
25805	20mm (3/4")	15mm(1/2")	Brass	Brass
25808	25mm (1")	25mm (1")	Brass	Brass
25809	32mm (1-1/4")	32mm (1-1/4")	Brass	Brass
25811	40mm(1-1/2")	40mm(1-1/2")	Brass	Brass
25817	50mm(2")	50mm(2")	Brass	Brass



Hose Coller Grooved Union Inner End

Art No.	Thread Size	Type	Material	Finish
26105	15mm (1/2")	Inner	Brass	Brass
26106	20mm (3/4")	Inner	Brass	Brass



Water Meter Nut Nipple

Art No.	Thread Size 1	Type	Thread Size 2	Type	Material	Finish
28007	20mm (3/4")	Inner	15mm (1/2")	Outer	Brass	Brass
28009	25mm (1")	Inner	20mm (3/4")	Outer	Brass	Brass



Union

Art No.	Thread Size	Material	Finish
28205	15mm (1/2")	Brass	Brass
28206	20mm (3/4")	Brass	Brass



Tee

Art No.	Thread Size 1	Thread Size 2	Material	Finish
25602	15mm (1/2")	15mm (1/2")	Brass	Brass
25604	20mm (3/4")	20mm (3/4")	Brass	Brass
25608	20mm (3/4")	15mm(1/2")	Brass	Brass
25611	25mm (1")	25mm (1")	Brass	Brass
25613	25mm(1")	20mm(3/4")	Brass	Brass



Socket

Art No.	Thread Size 1	Thread Size 2	Material	Finish
25702	15mm (1/2")	15mm (1/2")	Brass	Brass
25703	20mm (3/4")	20mm (3/4")	Brass	Brass
25705	20mm (3/4")	15mm(1/2")	Brass	Brass



Hose Coller Grooved Union Outer End

Art No.	Thread Size	Material	Finish
25903	8mm (1/4")	Brass	Brass
25904	10mm (3/8")	Brass	Brass
25905	15mm (1/2")	Brass	Brass
25906	20mm (3/4")	Brass	Brass
25907	25mm (1")	Brass	Brass
25908	32mm (1 1/4")	Brass	Brass
25909	40mm (1 1/2")	Brass	Brass
25917	50mm (2")	Brass	Brass



Full Thread Nipple Fixed Checknut

Art No.	Thread Size	Type	Length	Material	Finish
27705	15mm (1/2")	Outer	65mm (2 1/2")	Brass	Brass
27706	20mm (3/4")	Outer	57mm (2 1/4")	Brass	Brass
27707	25mm (1")	Outer	65mm (2 1/2")	Brass	Brass
27708	32mm (1 1/4")	Outer	65mm (2 1/2")	Brass	Brass
27709	40mm (1 1/2")	Outer	65mm (2 1/2")	Brass	Brass
27717	50mm (2")	Outer	57mm (2 1/4")	Brass	Brass



Bend

Art No.	Thread Size	Material	Finish
28505	15mm (1/2")	Brass	Brass
28506	20mm (3/4")	Brass	Brass
28509	25mm (1")	Brass	Brass



Drain Flat Round
-With Lock
-Plastic Coated



Drain Flat with Frame
-With Lock
-Plastic Coated



Drain Flat Slotted
-With Lock
-Plastic Coated



Drain Flat Slotted with Frame
-With Lock
-Plastic Coated



Drain Flat Round
-With Lock
-Plastic Coated



Drain Flat Square
-With Lock
-Plastic Coated

Art No.	Dia	Finish	Material	Hole For Waste Pipe
40905A	125mm (5")	Polished	SS 430	×
40906 A	125mm (5")	Polished	SS 430	✓
39238	125mm (5")	Brushed	SS 304	×
39240	125mm (5")	Brushed	SS 304	✓

Art No.	Length	Breadth	Finish	Material	Hole For Waste Pipe
40913	100mm(4")	100mm(4")	Polished	SS 430	×
40914	100mm(4")	100mm(4")	Polished	SS 430	✓
40915 A	125mm(5")	125mm(5")	Polished	SS 430	×
40916 A	125mm(5")	125mm(5")	Polished	SS 430	✓
39242	125mm(5")	125mm(5")	Brushed	SS 304	×
39245	125mm(5")	125mm(5")	Brushed	SS 304	✓
39250	150mm(6")	150mm(6")	Brushed	SS 304	×
39251	150mm(6")	150mm(6")	Brushed	SS 304	✓
40920	150mm(6")	150mm(6")	Polished	SS 430	×
40921	150mm(6")	150mm(6")	Polished	SS 430	✓

Art No.	Dia	Finish	Material	Hole For Waste Pipe
40905 B	125mm (5")	Polished	SS 430	×
40906 B	125mm (5")	Polished	SS 430	✓
39335	125mm (5")	Brushed	SS 304	×
39336	125mm (5")	Brushed	SS 304	✓

Art No.	Length	Breadth	Finish	Material	Hole For Waste Pipe
40915 B	125mm(5")	125mm(5")	Polished	SS 430	×
40916 B	125mm(5")	125mm(5")	Polished	SS 430	✓
39340	125mm(5")	125mm(5")	Brushed	SS 304	×
39341	125mm(5")	125mm(5")	Brushed	SS 304	✓
39350	150mm(6")	150mm(6")	Brushed	SS 304	×
39351	150mm(6")	150mm(6")	Brushed	SS 304	✓
40920 B	150mm(6")	150mm(6")	Polished	SS 430	×
40921 B	150mm(6")	150mm(6")	Polished	SS 430	✓

Art No.	Dia	Finish	Material	Hole For Waste Pipe
40905 F	125mm(5")	Polished	SS 430	×
40906 F	125mm(5")	Polished	SS 430	✓
39215	125mm(5")	Brushed	SS 304	×
39216	125mm(5")	Brushed	SS 304	✓

Art No.	Length	Breadth	Finish	Material	Hole For Waste Pipe
40915 F	125mm(5")	125mm(5")	Polished	SS 430	×
40916 F	125mm(5")	125mm(5")	Polished	SS 430	✓
39220	125mm(5")	125mm(5")	Brushed	SS 304	×
39221	125mm(5")	125mm(5")	Brushed	SS 304	✓



Drain Flat Round
-With Lock
-Plastic Coated

Art No.	Dia	Finish	Material	Hole For Waste Pipe
40905 H	125mm(5")	Polished	SS 430	×
40906 H	125mm(5")	Polished	SS 430	✓
39260	125mm(5")	Brushed	SS 304	×
39262	125mm(5")	Brushed	SS 304	✓



Drain Flat Square
-With Lock
-Plastic Coated

Art No.	Length	Breadth	Finish	Material	Hole For Waste Pipe
40915 H	125mm(5")	125mm(5")	Polished	SS 430	×
40916 H	125mm(5")	125mm(5")	Polished	SS 430	✓
39265	125mm(5")	125mm(5")	Brushed	SS 304	×
39268	125mm(5")	125mm(5")	Brushed	SS 304	✓



**Cockroach Trap of
Drain-40905(BHF) & 40915(BHF)**

Art No.	Size (Dia)	Finish	Material	Hole For Waste Pipe
40925	125mm(5")	Polished	SS 430	N.A.



Trap for Drain

Art No.	Dia	Finish	Material	Hole For Waste Pipe
39588	125mm(5")	Black	Polypropylene (PP)	N.A.
39590	150mm(6")	Black	Polypropylene (PP)	N.A.



Drain Flat Square

Art No.	Length	Breadth	Finish	Material	Hole For Waste Pipe
39594	125mm(5")	125mm(5")	Brushed	SS 304	×
39595	125mm(5")	125mm(5")	Brushed	SS 304	✓

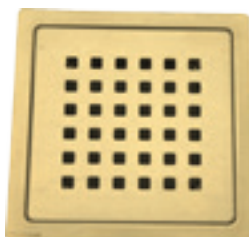

Drain Flat Square

Art No.	Length	Breadth	Finish	Material	Hole For Waste Pipe
39594 G	125mm(5")	125mm(5")	Gold PVD	SS 304	×

Drain in SS 316



Drain Flat Square

Art No.	Length	Breadth	Finish	Material	Hole For Waste Pipe
39400	125mm(5")	125mm(5")	Brushed	SS 316	×



Drain Flat Square

Art No.	Length	Breadth	Finish	Material	Hole For Waste Pipe
39405	125mm(5")	125mm(5")	Brushed	SS 316	×



Drain Flat Square

Art No.	Length	Breadth	Finish	Material	Hole For Waste Pipe
39415	150mm(6")	150mm(6")	Brushed	SS 316	×



Drain Flat Square

Art No.	Length	Breadth	Finish	Material	Hole For Waste Pipe
39420	150mm(6")	150mm(6")	Brushed	SS 316	×

GLAMOROUS TOUCH WITH VIKING TILE/ MARBLE DRAIN

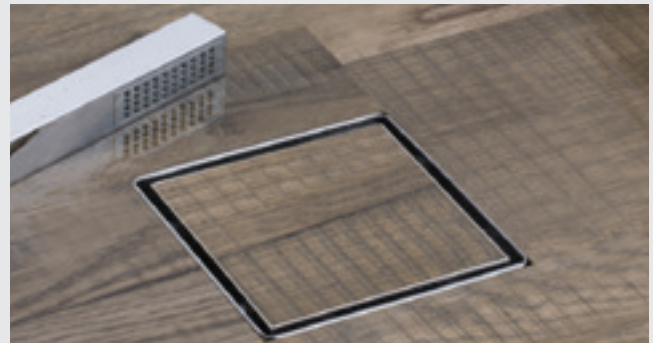
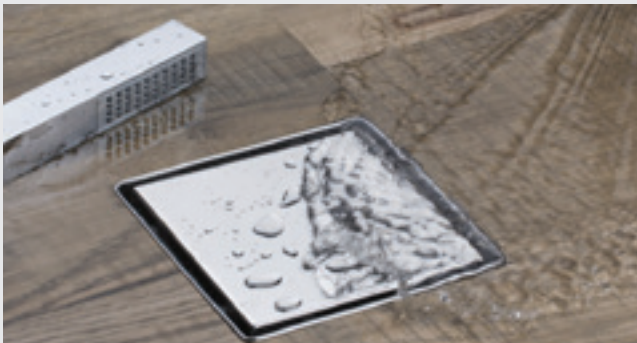

Tile Marble Drain

Art No.	Length	Breadth	Finish	Material	Hole For Waste Pipe
39695	100mm (4")	100mm (4")	Brushed	SS 304	×
39700	125mm(5")	125mm(5")	Brushed	SS 304	×
39720	150mm(6")	150mm(6")	Brushed	SS 304	×
39735	300mm(12")	300mm(12")	Brushed	SS 304	×
39700.02 (Tile Holding Plate)			Brushed	SS 304	×
39720.02 (Tile Holding Plate)			Brushed	SS 304	×

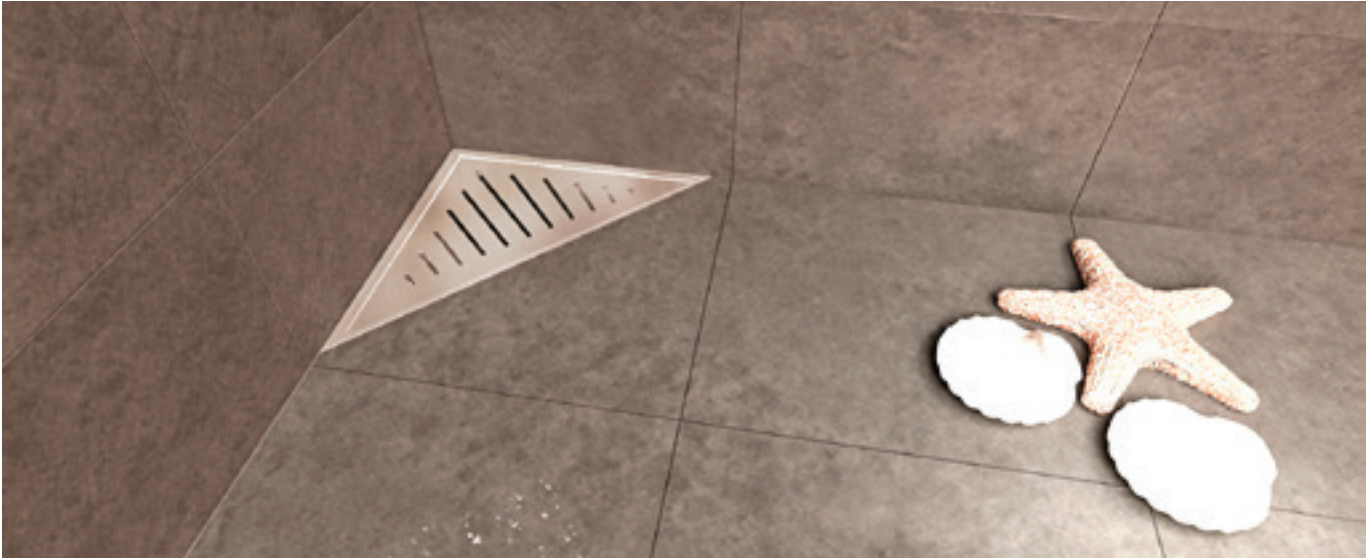

Slope of Bathroom is usually in a corner so having Corner Drain in corner will avoid all standing water. Ideal for Hotels, Malls, Restaurants, Hospitals, Commercial & Official Places.

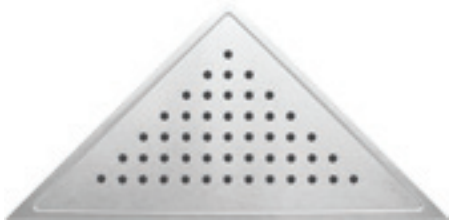

Corner Drain

Art No.	Length	Breadth	Finish	Material	Hole For Waste Pipe
39550A	250mm(10")	250mm(10")	Brushed	SS 430	N.A.

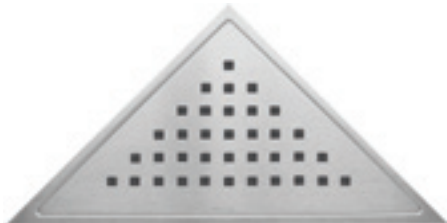

Corner Drain

Art No.	Length	Breadth	Finish	Material	Hole For Waste Pipe
39550B	250mm(10")	250mm(10")	Brushed	SS 430	N.A.



Corner Drain

Art No.	Length	Breadth	Finish	Material	Hole For Waste Pipe
39550C	250mm(10")	250mm(10")	Brushed	SS 430	N.A.



Corner Drain

Art No.	Length	Breadth	Finish	Material	Hole For Waste Pipe
39550D	250mm(10")	250mm(10")	Brushed	SS 430	N.A.



Square Drain

Art No.	Length	Breadth	Finish	Material	Hole For Waste Pipe
39604	150mm(6")	150mm(6")	Brushed	SS 304	✓
39605	150mm(6")	150mm(6")	Brushed	SS 304	✓
39607 (With Screw)	150mm(6")	150mm(6")	Brushed	SS 304	✗

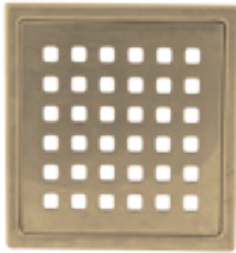

Square Drain

Art No.	Length	Breadth	Finish	Material	Hole For Waste Pipe
39604 G	150mm(6")	150mm(6")	Gold PVD	SS 304	✗



Square Drain

Art No.	Length	Breadth	Finish	Material	Hole For Waste Pipe
39610	150mm(6")	150mm(6")	Brushed	SS 304	✗
39611	150mm(6")	150mm(6")	Brushed	SS 304	✓
39613 (With Screw)	150mm(6")	150mm(6")	Brushed	SS 304	✗



Square Drain

Art No.	Length	Breadth	Finish	Material	Hole For Waste Pipe
39620	150mm(6")	150mm(6")	Brushed	SS 304	×
39621	150mm(6")	150mm(6")	Brushed	SS 304	✓
39623 (With Screw)	150mm(6")	150mm(6")	Brushed	SS 304	×



Square Drain

Art No.	Length	Breadth	Finish	Material	Hole For Waste Pipe
39628	150mm(6")	150mm(6")	Brushed	SS 304	×
39629	150mm(6")	150mm(6")	Brushed	SS 304	✓
39631 (With Screw)	150mm(6")	150mm(6")	Brushed	SS 304	✓



Square Drain

Art No.	Length	Breadth	Finish	Material	Hole For Waste Pipe
39635	150mm(6")	150mm(6")	Brushed	SS 304	×
39636	150mm(6")	150mm(6")	Brushed	SS 304	✓
39638 (With Screw)	150mm(6")	150mm(6")	Brushed	SS 304	✓



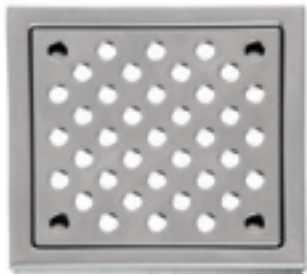

German Drain Square

Art No.	Length	Breadth	Finish	Material	Hole For Waste Pipe
40865	100mm(4")	100mm(4")	Polished	SS 430	×



German Drain Dip Hole Technology-Square

Art No.	Length	Breadth	Finish	Material	Hole For Waste Pipe
40890	125mm(5")	125mm(5")	Polished	SS 430	×
40891	125mm(5")	125mm(5")	Polished	SS 430	✓
40892	150mm(6")	150mm(6")	Polished	SS 430	×
40893	150mm(6")	150mm(6")	Polished	SS 430	✓



German Drain Dip Hole Technology-Round

Art No.	Dia	Finish	Material	Hole For Waste Pipe
40902	125mm(5")	Polished	SS 430	×
40903	125mm(5")	Polished	SS 430	✓



German Drain Flair

Best Seller

Art No.	Dia	Finish	Material	Hole For Waste Pipe
40904	125mm(5")	Polished	SS 430	×
40907	125mm(5")	Polished	SS 430	✓



Drain Round With Frame

Best Seller

Art No.	Dia	Finish	Material	Hole For Waste Pipe
41003	75mm(3")	Polished	SS 201	×
41004	100mm(4")	Polished	SS 201	×
41005	125mm(5")	Polished	SS 201	×
41015	125mm(5")	Polished	SS 201	✓
41020	125mm(5")	Polished	SS 304	×
41021	125mm(5")	Polished	SS 304	✓



Drain Round Hinged

Art No.	Dia	Finish	Material	Hole For Waste Pipe
41103	100mm (4")	Polished	SS 201	✗
41105	125mm(5")	Polished	SS 201	✗
41115	125mm(5")	Polished	SS 201	✓



Best Seller

Drain Round - One Piece

Art No.	Dia	Finish	Material	Hole For Waste Pipe
41302	50mm(2")	Polished	SS 201	✗
41313	75mm(3")	Polished	SS 201	✗
41324	100mm(4")	Polished	SS 201	✗
41325	100mm(4")	Polished	SS 201	✓
41335	125mm(5")	Polished	SS 201	✗
41336	125mm(5")	Polished	SS 201	✓



Use "F" Followed by code for Flat Drain e.g. 41505 F

Drain Square

Art No.	Length	Breadth	Finish	Material	Hole For Waste Pipe
41505	125mm(5")	125mm(5")	Polished	SS 201	✗
41515	125mm(5")	125mm(5")	Polished	SS 201	✓
41517	125mm(5")	125mm(5")	Polished	SS 304	✗
41519	125mm(5")	125mm(5")	Polished	SS 304	✓
41526	150mm(6")	150mm(6")	Polished	SS 201	✗
41536	150mm(6")	150mm(6")	Polished	SS 201	✓
41540	150mm(6")	150mm(6")	Polished	SS 304	✗
41541	150mm(6")	150mm(6")	Polished	SS 304	✓
41588	200mm(8")	200mm(8")	Polished	SS 201	✗



Drain Square Hinged

Art No.	Length	Breadth	Finish	Material	Hole For Waste Pipe
41705	125mm(5")	125mm(5")	Polished	SS 201	✗
41715	125mm(5")	125mm(5")	Polished	SS 201	✓
41718	100mm(4")	100mm(4")	Polished	SS 201	✗
41719	100mm(4")	100mm(4")	Polished	SS 201	✓
41726	150mm(6")	150mm(6")	Polished	SS 201	✗
41736	150mm(6")	150mm(6")	Polished	SS 201	✓



Drain Square - One Piece

Art No.	Length	Breadth	Finish	Material	Hole For Waste Pipe
41810	125mm(5")	125mm(5")	Polished	SS 201	✗
41811	125mm(5")	125mm(5")	Polished	SS 201	✓
41816	150mm(6")	150mm(6")	Polished	SS 201	✗
41818	150mm(6")	150mm(6")	Polished	SS 201	✓



42001

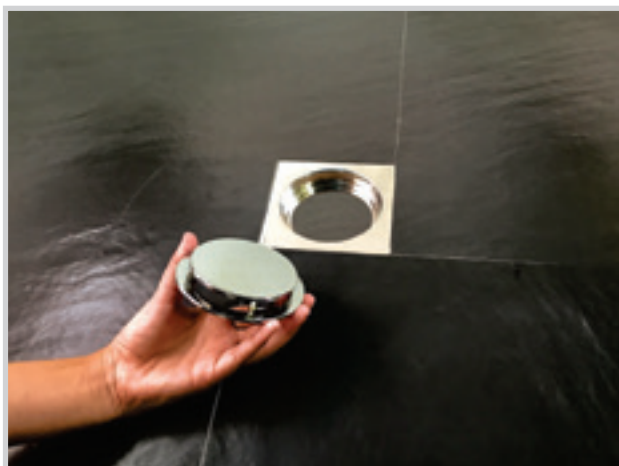

42001 Open View



Best Seller

Aussie Drain

- Other Finishes available on Request

Art No.	Length	Breadth	Finish	Material	Hole For Waste Pipe
42001	125mm(5")	125mm(5")	Polished CP	Brass	✗
42002	125mm(5")	125mm(5")	Polished CP	Brass	✓
42001.02 (Cover)			Polished CP	Brass	✗
42002.02 (Cover)			Polished CP	Brass	✓



Aussie Drain

Art No.	Length	Breadth	Finish	Material	Hole For Waste Pipe
42001 G	125mm(5")	125mm(5")	Gold PVD	Brass	✗
42001G.02 (Cover)			Gold PVD	Brass	✗

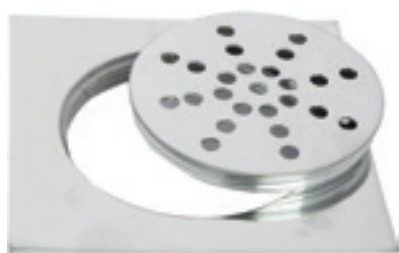

Drain Square Threaded-Brass

Art No.	Length	Breadth	Finish	Material	Hole For Waste Pipe
42004	100mm(4")	100mm(4")	Polished CP	Brass	✗
42014	100mm(4")	100mm(4")	Polished CP	Brass	✓
42025	125mm(5")	125mm(5")	Polished CP	Brass	✗
42035	125mm(5")	125mm(5")	Polished CP	Brass	✓



Drain Flat Running (Swimming Pool)
- Sizes Available on Request

Art No.	Length	Breadth	Finish	Material	Centre Hole/ Side Hole
44550	450mm(18")	150mm(6")	Brushed	SS 304	
44552	600mm(24")	150mm(6")	Brushed	SS 304	
44554	900mm(26")	175mm(7")	Brushed	SS 304	
44556	1200mm(48")	175mm(7")	Brushed	SS 304	



Drain Flat Running (Swimming Pool)
- Sizes Available on Request

Art No.	Length	Breadth	Finish	Material	Centre Hole/ Side Hole
44562	450mm(18")	200mm(8")	Brushed	SS 304	
44564	600mm(24")	200mm(8")	Brushed	SS 304	
44566	900mm(26")	200mm(8")	Brushed	SS 304	
44568	1200mm(48")	200mm(8")	Brushed	SS 304	



Tile/Marble Shower Channel Drain

Art No.	Length	Breadth	Finish	Material	Centre Hole/ Side Hole
44650	300mm(12")	82mm	Brushed	SS 304	Side Hole
44652	600mm(24")	82mm	Brushed	SS 304	Side Hole
44652.01 (Tile Insert Plate (Top Part))	600mm(24")		Brushed	SS 304	
44653	600mm(24")	82mm	Brushed	SS 304	Centre Hole
44655	900mm(36")	82mm	Brushed	SS 304	Side Hole
44656	900mm(36")	82mm	Brushed	SS 304	Centre Hole
44658	1200mm(48")	82mm	Brushed	SS 304	Side Hole
44659	1200mm(48")	82mm	Brushed	SS 304	Centre Hole





Shower Channel Drain-Curves

Art No.	Length	Breadth	Finish	Material	Centre Hole/ Side Hole
44668	300mm(12")	100mm(4")	Brushed	SS 304	Side Hole
44673	600mm(24")	100mm(4")	Brushed	SS 304	Side Hole
44675	600mm(24")	100mm(4")	Brushed	SS 304	Centre Hole
44678	900mm(36")	100mm(4")	Brushed	SS 304	Side Hole
44679	900mm(36")	100mm(4")	Brushed	SS 304	Centre Hole
44681	1200mm(48")	100mm(4")	Brushed	SS 304	Side Hole
44682	1200mm(48")	100mm(4")	Brushed	SS 304	Centre Hole

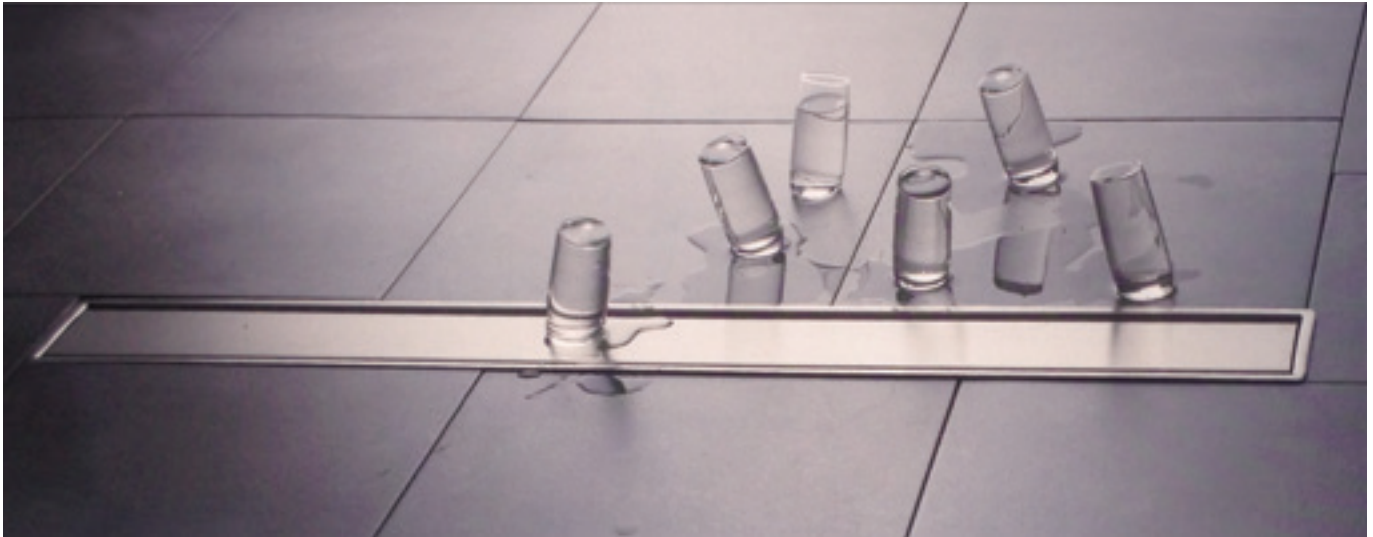

Shower Channel Drain

Note : 44690 D have 2 side holes for fast drainage.

Art No.	Length	Breadth	Finish	Material	Centre Hole/ Side Hole
44686	300mm(12")	100mm(4")	Brushed	SS 304	Side Hole
44688	450mm(18")	100mm(4")	Brushed	SS 304	Side Hole
44689	450mm(18")	100mm(4")	Brushed	SS 304	Centre Hole
44690	600mm(24")	100mm(4")	Brushed	SS 304	Side Hole
44690.03 (Cockroach Trap-Assembly)					
44690 D	600mm(24")	100mm(4")	Brushed	SS 304	2 Side Hole
44691	600mm(24")	100mm(4")	Brushed	SS 304	Centre Hole
44692	900mm(36")	100mm(4")	Brushed	SS 304	Side Hole
44693	900mm(36")	100mm(4")	Brushed	SS 304	Centre Hole
44694	1200mm(48")	100mm(4")	Brushed	SS 304	Side Hole
44695	1200mm(48")	100mm(4")	Brushed	SS 304	Centre Hole
44705	600mm(24")	125mm(5")	Brushed	SS 304	Side Hole
44710	900mm(36")	125mm(5")	Brushed	SS 304	Side Hole
44715	1200mm(48")	125mm(5")	Brushed	SS 304	Centre Hole



Shower Channel Drain

Art No.	Length	Breadth	Finish	Material	Centre Hole/ Side Hole
44698	600mm(24")	100mm(4")	Gold PVD	SS 304	Side Hole



Shower Channel Drain

Art No.	Length	Breadth	Finish	Material	Centre Hole/ Side Hole
44786	300mm(12")	100mm(4")	Brushed	SS 304	Centre Hole
44790	600mm(24")	100mm(4")	Brushed	SS 304	Side Hole
44791	600mm(24")	100mm(4")	Brushed	SS 304	Centre Hole
44792	900mm(36")	100mm(4")	Brushed	SS 304	Side Hole
44793	900mm(36")	100mm(4")	Brushed	SS 304	Centre Hole
44794	1200mm(48")	100mm(4")	Brushed	SS 304	Side Hole
44795	1200mm(48")	100mm(4")	Brushed	SS 304	Centre Hole



Drain Cover-Grate

Art No.	Length	Breadth	Finish	Material	Hole For Waste Pipe
44970	200mm(8")	200mm(8")	Brushed	SS 430	×



Drain Cover-Grate

Art No.	Length	Breadth	Finish	Material	Hole For Waste Pipe
44972	200mm(8")	200mm(8")	Brushed	SS 430	×



Drain Cover-Grate

Art No.	Length	Breadth	Finish	Material	Hole For Waste Pipe
44980	200mm(8")	200mm(8")	Brushed	SS 430	×
44985	250mm(10")	250mm(10")	Brushed	SS 430	×
44990	300mm(12")	300mm(12")	Brushed	SS 430	×



Rain Roof Drain Grate-Round

Art No.	Dia	Finish	Material	Hole For Waste Pipe
45093	50mm(2")	Polished	SS 201	✗
45095	75mm(3")	Polished	SS 201	✗
45096	75mm(3")	Polished	SS 201	✓
45097	100mm(4")	Polished	SS 201	✗
45098	100mm(4")	Polished	SS 201	✓
45100	125mm(5")	Polished	SS 201	✗
45101	125mm(5")	Polished	SS 201	✓



Rain Roof Drain Grate Square

Art No.	Length	Breadth	Finish	Material	Hole For Waste Pipe
45103	75mm(3")	75mm(3")	Polished	SS 201	✗
45104	75mm(3")	75mm(3")	Polished	SS 201	✓
45105	100mm(4")	125mm(5")	Brushed	SS 304	✗
45109	100mm(4")	100mm(4")	Polished	SS 201	✗
45110	100mm(4")	100mm(4")	Polished	SS 201	✓
45111	125mm(5")	125mm(5")	Polished	SS 201	✗
45115	125mm(5")	125mm(5")	Polished	SS 201	✓
45112	150mm(6")	150mm(6")	Polished	SS 201	✗
45116	150mm(6")	150mm(6")	Polished	SS 201	✓



Balcony Roof Drain

Art No.	Length	Breadth	Height	Finish	Material	Hole For Waste Pipe
45128	100mm(4")	50mm(2")	50mm(2")	Polished	SS 201	✗
45130	125mm(5")	65mm(2.6")	65mm(2.6")	Polished	SS 201	✗
45132	150mm(6")	75mm(3")	75mm(3")	Polished	SS 201	✗



Roof Balcony Drain Round-Dome

Art No.	Dia	Finish	Material	Hole For Waste Pipe
45140	125mm(5")	Polished	SS 201	✗



Roof Balcony Drain Square-Dome

Art No.	Length	Breadth	Finish	Material	Hole For Waste Pipe
45145	125mm(5")	125mm(5")	Polished	SS 201	✗

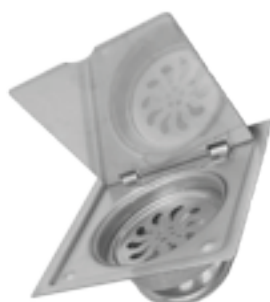

Drain Hinged With Trap

Art No.	Length	Breadth	Finish	Material	Hole For Waste Pipe
45200	125mm(5")	125mm(5")	Brushed	SS 304	✗
45203	150mm(6")	150mm(6")	Brushed	SS 304	✗



Floor Drain Flat Pop Up Round

Art No.	Dia	Finish	Material	Hole For Waste Pipe
45205	125mm(5")	Polished	SS 304	×



Floor Drain Flat Pop Up Square

Art No.	Length	Breadth	Finish	Material	Hole For Waste Pipe
45215	125mm(5")	125mm(5")	Polished	SS 304	×
45218	150mm(6")	150mm(6")	Polished	SS 304	×



Aussie Cockroach Trap

Art No.	Length	Breadth	Finish	Material	Hole For Waste Pipe
45225	125mm(5")	125mm(5")	Polished CP	Brass	×
45226	125mm(5")	125mm(5")	Polished CP	Brass	✓

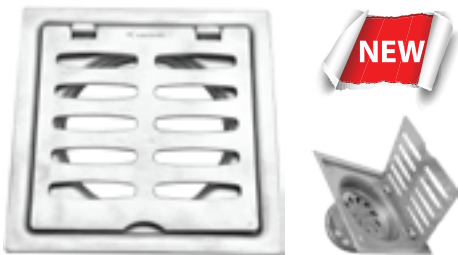

Drain Hinged With Trap

Art No.	Length	Breadth	Finish	Material	Hole For Waste Pipe
45250	125mm(5")	125mm(5")	Brushed	SS 304	×
45255	150mm(6")	150mm(6")	Brushed	SS 304	×

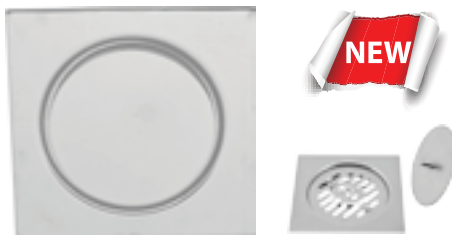

Drain-Double Layered With Gap

Art No.	Length	Breadth	Finish	Material	Hole For Waste Pipe
45275	150mm(6")	150mm(6")	Brushed	SS 304	×



Drain - Double Layer

Art No.	Length	Breadth	Finish	Material	Hole For Waste Pipe
45280	150mm(6")	150mm(6")	Brushed	SS 304	×



Anti Foul Drain Round Cockroach Trap

Art No.	Dia	Finish	Material	Hole For Waste Pipe (With/Without Hole Provision)
46305	125mm(5")	Polished	SS 304	



Anti Foul Drain Square Cockroach Trap

Art No.	Length	Breadth	Finish	Material	Hole For Waste Pipe (With/Without Hole Provision)
46315	125mm(5")	125mm(5")	Polished	SS 304	



**Drain With Cockroach Trap Round
- 2 Bowls Type**

Art No.	Dia	Finish	Material	Hole For Waste Pipe
47405	125mm(5")	Polished	SS 201	×
47415	125mm(5")	Polished	SS 201	✓
47420	125mm(5")	Polished	SS 304	×
47422	125mm(5")	Polished	SS 304	✓



**Drain With Cockroach Trap Round-Slotted
- 2 Bowls Type**

Art No.	Dia	Finish	Material	Hole For Waste Pipe
47425	125mm(5")	Polished	SS 304	×
47426	125mm(5")	Polished	SS 304	✓



**Drain With Cockroach Trap Square
- 2 Bowls Type**

Art No.	Length	Breadth	Finish	Material	Hole For Waste Pipe
48505	125mm(5")	125mm(5")	Polished	SS 201	×
48505.03 (Trap Assembly For 47405, 48505, 48536)				SS 201	
48515	125mm(5")	125mm(5")	Polished	SS 201	✓
48516	125mm(5")	125mm(5")	Polished	SS 304	×
48517	125mm(5")	125mm(5")	Polished	SS 304	✓
48526	150mm(6")	150mm(6")	Polished	SS 201	×
48536	150mm(6")	150mm(6")	Polished	SS 201	✓
48540	150mm(6")	150mm(6")	Polished	SS 304	×
48542	150mm(6")	150mm(6")	Polished	SS 304	✓



**Drain With Cockroach Trap Square-Slotted
- 2 Bowls Type**

Art No.	Length	Breadth	Finish	Material	Hole For Waste Pipe
48518	125mm(5")	125mm(5")	Polished	SS 304	×
48519	125mm(5")	125mm(5")	Polished	SS 304	✓
48545	150mm(6")	150mm(6")	Polished	SS 304	×
48546	150mm(6")	150mm(6")	Polished	SS 304	✓

Front window slit to check paper level.
Dispenser can be locked of 53600, 53605 & 53800 .

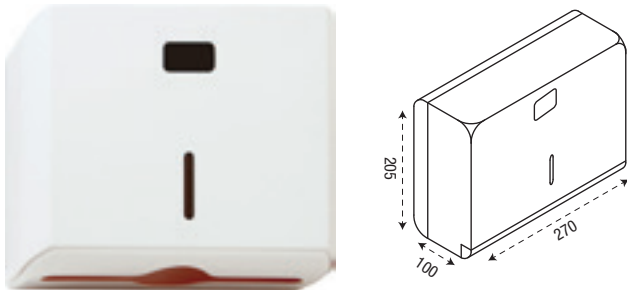

Dispenser For Paper Towel

Art No.	Length	Breadth	Height	Material	Colour	Capacity
53600	270mm	100mm	205mm	ABS	White	300-400

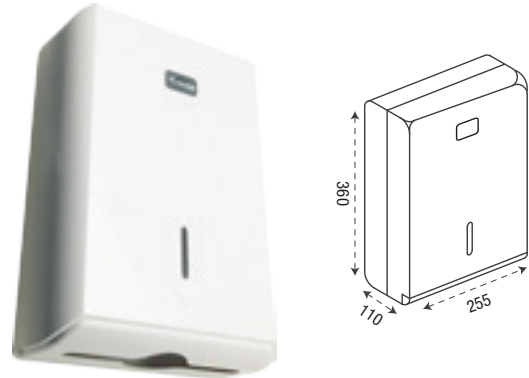

Dispenser For Paper Towel

Art No.	Length	Breadth	Height	Material	Colour	Capacity
53605	255mm	110mm	360mm	ABS	White	450-600

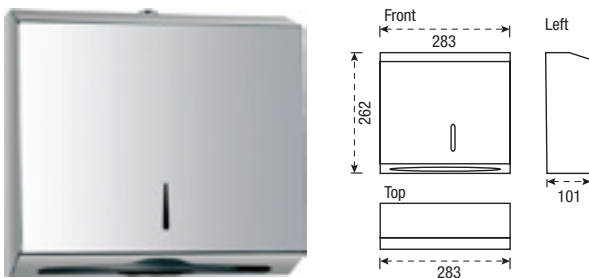

Dispenser For Paper Towel

Art No.	Length	Breadth	Height	Material	Colour	Capacity
53800	283mm	101mm	262mm	SS 304	Polished	300-400

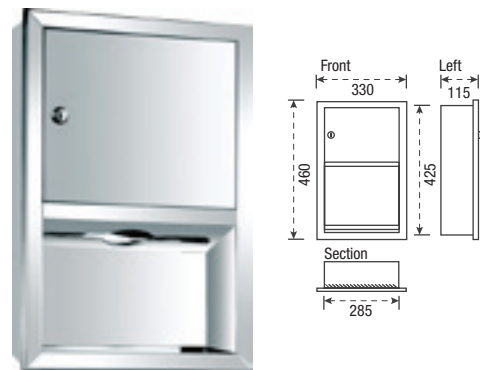

Dispenser in Box For Paper Towel

Art No.	Length	Breadth	Height	Material	Colour	Capacity
53850	330mm	115mm	460mm	SS 304	Polished	300-400

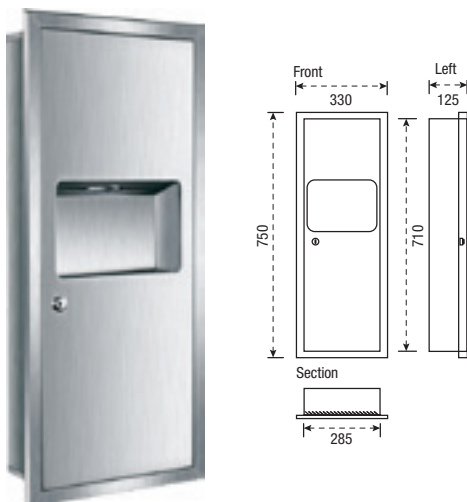

Dispenser & Dustbin For Paper Towel

Art No.	Length	Breadth	Height	Material	Colour	Capacity
53900	330mm	125mm	750mm	SS 304	Polished	300-400

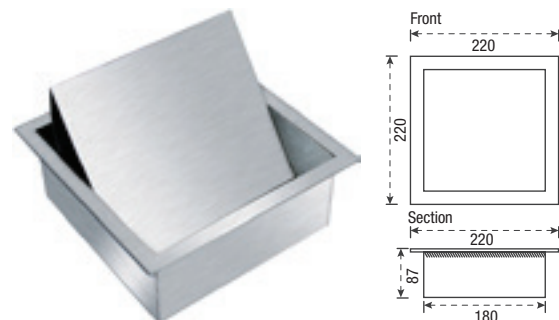

Dustbin Cover Counter Mounted

Art No.	Length	Breadth	Height	Material	Finish
54000	220mm	87mm	220mm	SS 304	Polished



Robe Hook

Art No.	Material	Finish
56331	Zamak	Polished CP



Robe Hook

Art No.	Material	Finish
56333	Zamak	Polished CP



Robe Hook

Art No.	Material	Finish
56334	Zamak	Polished CP



Robe Hook

Art No.	Material	Finish
56350	Zamak	Polished CP



Voltage : 220V (50Hz-60Hz)
Air Speed: 15M/S

Body Dryer

Art No.	Length	Breadth	Height	Material	Colour
58021	205cm	110cm	580cm	ABS	Ivory



Voltage : 220V (50Hz-60Hz)
Air Speed: 13M/S

Hair Dryer

Art No.	Length	Breadth	Height	Material	Colour
58024	110cm	140cm	245cm	ABS Body	White



Voltage : 220V (50Hz-60Hz)
Air Speed: 16M/S

Hand Dryer
-Low Traffic

Art No.	Length	Breadth	Height	Material	Colour
58131	265mm	155mm	200mm	ABS Body	Ivory



Voltage : 220V (50Hz-60Hz)
Air Speed: 60M/S

Hand Dryer
-High Traffic

Art No.	Length	Breadth	Height	Material	Finish
58135	295mm	170mm	325mm	SS 304	Mirror



Voltage : 220V (50Hz-60Hz)
Air Speed: 40M/S

Hand Dryer
-Medium Traffic

Art No.	Length	Breadth	Height	Material	Finish
58142	248mm	175mm	250mm	ABS	Dark Silver



Line blocked!!!
try the plunger
before you brake
your tiles.

Toilet Plunger (WC Cleaner)

Art No.
62000



WC PAN Connector-Offset

Art No.	Length	Dia	Material	Finish
62245	125mm(5")	110mm	Plastic	White



WC PAN Connector-Straight

Art No.	Length	Dia	Material	Finish
62250	125mm(5")	110mm	Plastic	White



Door Sign

Art No.	Breadth	Material	Finish
66950 M	63mm (2.5")	SS 304	Brushed
66950 F	63mm (2.5")	SS 304	Brushed
66950 MF	63mm (2.5")	SS 304	Brushed



Spindle

Art No.	Thread Size	Material	Finish
79880	15mm (1/2")	Brass	Brass
79900	20mm(3/4")	Brass	Brass



Nozzle For Fountains And Car Wash

Art No.	Thread Size	Material	Finish
80100	15mm (1/2")	Brass	Polished CP
80105	15mm (1/2")	Brass	Polished CP
80108	8mm(1/4")	Brass	CP



Fountain Nozzle
- With Flow Control for Height of Water.

Art No.	Thread Size	Material	Finish
80110	15mm (1/2")	Brass	CP



80110



80140



Water Fountain Pearl

Art No.	Thread Size	Material	Finish
80150	25mm (1")	Brass	Brass



Water Fountain Irish

Art No.	Thread Size	Material	Finish
80140	25mm (1")	Brass	Brass



Water Fountain Jade

Art No.	Thread Size	Material	Finish
80160	20mm (3/4")	Brass	Brass



80170



Best Seller

Water Fountain Flower

Art No.	Thread Size	Material	Finish
80170	40mm (1.1/2")	Brass	Brass



Best Seller

Water Fountain Crown

Art No.	Thread Size	Material	Finish
80180	40mm (1.1/2")	Brass	Brass



Best Seller

Water Fountain Opera

Art No.	Thread Size	Material	Finish
80190	20mm (3/4")	Brass	Brass



Water Fountain Dew

Art No.	Thread Size	Material	Finish
80200	25mm (1")	Brass	Brass

Ordering Information

Business Hours

- Monday to Saturday 9:30 am to 5:30 pm India Standard Time.

Ordering

1. Online Ordering:

- Please Sign up on www.vikingindia.com to place orders.

2. E-Mail Orders:

- orders@vikingindia.com can be placed 24 hrs 365 days a year.

3. Phone Orders:

- Orders can be placed **+91 -181- 260-4100, 260-4200, 5074100** during regular business hours Monday to Saturday.
- Courier Orders will dispatch on same day if the order is placed before 3 pm.
- Couriers Orders with waybill or any document required will be dispatched only if the waybill also received same day before 3 PM.
- All Viking product sales are Ex- our warehouse, hence customer has to pay Transportation, Packing Forwarding, Taxes and Insurance.

Taxes

- Taxes will be applicable as under Indian Law.

Important Information for Ordering

- Mention art no of the product

There can be many variants for a product. It's easier to identify when complete description is not mentioned. You can avoid mentioning description if art no is mentioned.

- Complete Name & Address with Customer ID

Viking has more than 2000 dealers across India. Full name and Address helps to identify your company. To Speed up the process simply mention your 3-6 Digit Customer Id which is mentioned next to your company name on invoice.

	TAX INVOICE ORIGINAL FOR RECIPIENT		CST No. : 03242088428 GSTIN : 03AAXFA6148E1ZE E Mail : aim@vikingindia.com WEBSITE www.vikingindia.com HDFC BANK LTD. GT ROAD JALANDHAR. A/C No.:-50200001371572 NEFT/RTGS CODE:HDFC0000046	
	AIM Tech Pathankot Road,Near Reru Pind Gate,Jalandhar-144012 Phone : 01812604200 PAN NO. : AAXFA6148E			
Invoice No. M/S. ABC - 58731 Pathankot Road Near Reru Pind Gate Jalandhar State Code: GSTIN: Phone : Fax :	C.I. No :	Order No. C. Order No. G.R. No. Transport Destination Weight Pvt. Mark	Dt. Dt. Dt. Freight P/Slip No.	58731-2

Order Inquiries

- If you have questions about an order you placed, you may reply to your email order confirmation, or call us during regular business hours of Monday to Saturday 9:30am to 5:30pm. Please have your order number available to help expedite your inquiry.

International Inquiries

- If you are overseas Customer please place your order or inquire through feedback@vikingindia.com

E-Mail Confirmations:

- Soon after placing your order, you will receive an email confirming about your order. In case you don't receive it please call us to avoid delay in orders. You will also receive a second email when your order has shipped (dispatched). The second email will include the tracking number and carrier's website (if applicable) that allows you to track the info of your order. The same information can be processed through sms also. In case you want to change information please login to your account to do the same. Same can be done by respective Viking sales Team Associate.

Changing (or Cancelling) an Order

- You can change or cancel an order after you have placed it, provided the order has not yet entered the shipping (Dispatch) process. We will do our best to act on any request to change or cancel order. However we process and ship orders quickly, so please notify us promptly on any such request.
- Cancellations or refusal of orders, which have already shipped, are subject to the minimum 10% handling and restocking charge as well as no refund for shipping charges. Custom made, manufactured to order cannot be cancelled.

Changes to Deliver Addresses

- If we are informed to change to a delivery address after the materials have left our location, we will try to have our carrier to reroute the materials. This doesn't guarantee that the logistic company will accept our request. This may result in additional charges on you.

Shipping or Transportation or Courier Service

- Viking will choose a suitable Logistic carrier in your area. To suggest a carrier (Transport or Courier) for your orders or documents please send an email to sales@vikingindia.com from your registered email id. Same can be done by your respective Viking sales team associate.

Terms & Conditions

Payment Terms:

- We accept payments via cheque, Draft, RTGS, NEFT and other electronic modes. No orders (shipments) are sent Cash on Delivery. Any invoice past 45 days will delay further orders.
- Viking reserves the right to change prices and specifications of Products and/or material without prior notice.

Receiving Merchandise

Shipment must be inspected in terms of

1. Number of parcel (cartons/Boxes) as on invoice.
2. Condition of the Boxes or cases must be good.
3. Gross weight of the shipment as per invoice.

- If all of above matches then you should sign Carrier document of receipt.
- But if your goods arrive in tampered or damaged condition you must notify your logistic company. Upon receiving your delivery of goods carefully verify inspect the goods. Customers are responsible to ensure all items are present as per invoice, If any Discrepancy is found you must notify us within 2 (two) working days, if

not Viking is not responsible for missing items.

- By signing logistic company Receipt without any notice of damage, you are agreeing that shipment (goods) arrive in good condition. Any damage found after that point cannot directed to logistic company. Viking loses power to file a freight damage claim once you confirm the shipment was received in good condition.

Viking is proud to celebrate the following Holidays. We will be closed and will not process or ship any orders on days listed below.

- 26th Jan (Republic Day)
- Holi
- 15th Aug (Independence Day)
- 2nd Oct (Gandhi Jayanti)
- Dussehra (till 3pm)
- Diwali
- Vishwakarma Day

Warranty Information

- **What does warranty Cover?**

Viking warrants that its products to be free from all defects in material and workmanship under normal usage for the Warranty period as mentioned on website.

- **How long Warranty lasts?**

Unless the warranty is specified, the Warranty period is two (2) years from the date of original sale, other than electrical or electronic goods which is one (1) year.

- **What will Viking Do?**

Upon receiving the product which Viking confirm is defective, Company will at its options either a) Repair or (authorize the repair of the products, b) Replace the products c) refund the purchase price for the product. Decision of Viking will be final. Failure to provide evidence of purchase by purchaser will waive off all claims made by the purchaser during the Warranty period.

Return Policy

- Authorization is required to return any material. Contact us for a return authorization number. List the items being returned with the reasons. Items must be unused and in original condition with all packaging, manuals and parts. Freight must be prepaid on returned material. Viking is not liable for returned goods that are lost or damaged during transit. It is responsibility of customer to securely pack the goods to reach Viking Warehouse.

Non-Returnable Material

- Custom made, manufactured to order cannot be returned for credit unless it's due to Viking error.

Intellectual Property

- Viking retains all rights to patents, trademarks, copyrights, trade secrets and other intellectual property rights. Purchaser obtains no rights to use of such intellectual property.

Product Photography

- Products are for representation only & may vary to th actual product. Colours are a guide only.

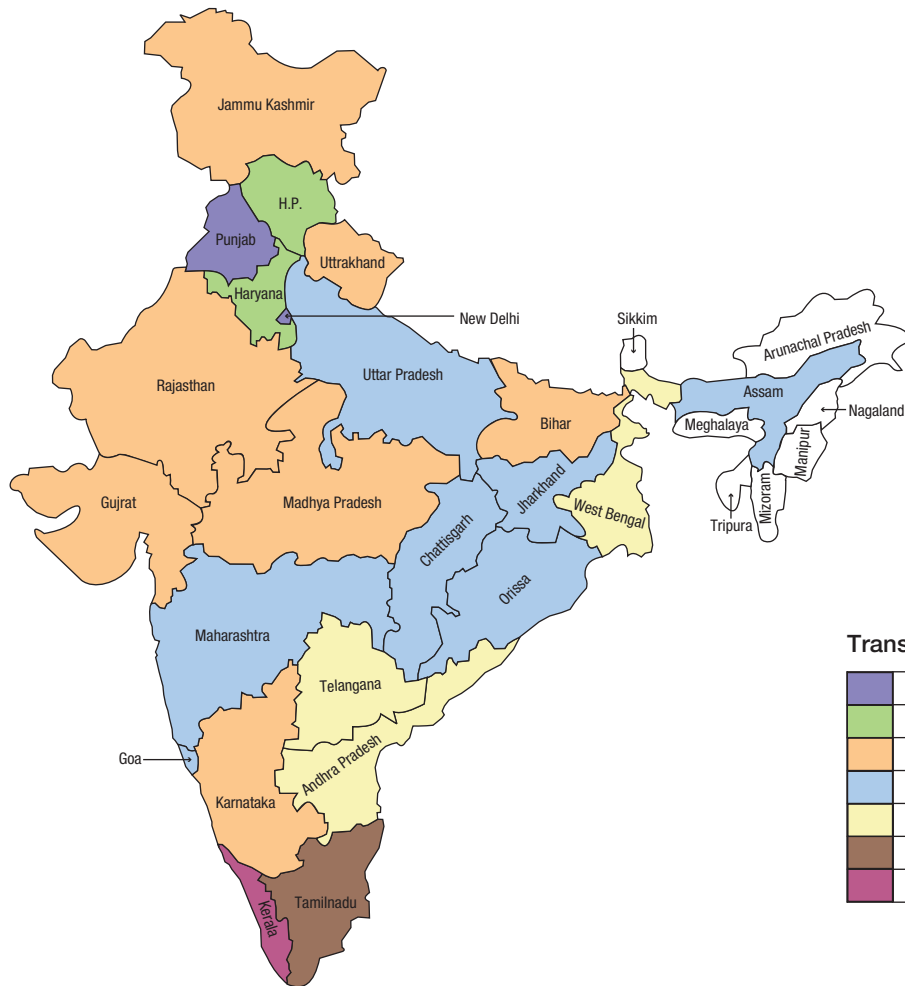

Courier Services

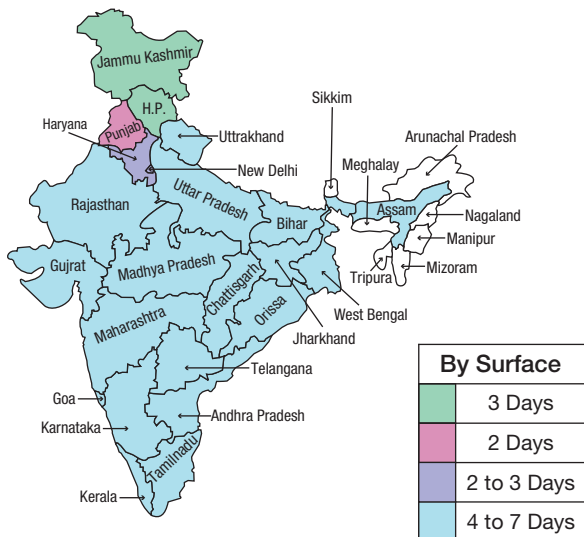

Terms & Conditions

- Door delivery available (extra charges may apply).
- Delivery days are approximate, VIKING (AIMTECH) cannot held responsible for delays in delivery.
- Major Cities and Town are likely to get goods in minimum period while small towns and villages can take maximum period in your zone.
- Logistic Charges can change without prior notice.

Art/Part Number	Page No.	Art/Part Number	Page No.	Art/Part Number	Page No.	Art/Part Number	Page No.	Art/Part Number	Page No.	Art/Part Number	Page No.	Art/Part Number	Page No.
700	1	1370	9	1680	16	1794 G	19	1952	24	2425	29	3624	32
701	1	1375	10	1681	16	1795 G	19	1953	24	2427	29	3636	32
701.02	1	1375.50	10	1681.02	16	1801	20	1954	24	2432	29	3648	32
717	2	1375.51	10	1682	16	1830	20	1955	24	2438	29	3660	32
718	2	1401	10	1683	16	1835	20	1956	24	2460	30	3672	32
728	2	1430	10	1683.02	16	1840	20	1957	24	2461	30	3712	32
751	2	1435	10	1685	16	1843	20	1958	24	2462	30	3718	32
752	2	1440	10	1687	16	1845	20	1966	24	2463	30	3724	32
1000	2	1443	10	1691	16	1850	20	1968	25	2465	30	3736	32
1001	2	1445	10	1691G	16	1855	20	1969	25	2467	30	3748	32
1003	2	1450	10	1693	16	1856	20	1971	25	2472	30	3760	32
1005	2	1455	10	1698	16	1860	20	1972	25	2478	30	3772	32
1010	2	1501	11	1699	16	1863	20	1973	25	2710	31	4412	32
1015	2	1530	11	1701	17	1865	21	1975	25	2985	31	4418	32
1020	2	1535	11	1702	17	1874	21	1976	25	3012	31	4424	32
1091	3	1540	11	1730	17	1885	21	1977	25	3018	31	4512	32
1092	3	1543	11	1730.05	17	1887	21	1979	25	3024	31	4921	33
1092.02	3	1545	11	1730.12	17	1889	21	1980	25	3036	31	4930	33
1095	3	1550	11	1734	17	1890	21	1985	25	3048	31	4930.02	33
1115	3	1560	11	1735	17	1891	21	1987	25	3049	31	4936	33
1120	3	1600	12	1735.50	17	1892	21	1999	25	3051	31	4945	33
1125	3	1601	12	1740	17	1893	21	1940G	26	3052	31	4947	33
1127	3	1601.03	12	1743	17	1895	21	1941G	26	3055	31	4950	33
1130	3	1601.05	12	1745	17	1920	22	1942G	26	3057	31	4965	33
1135	3	1602	12	1750	17	1921	22	1943G	26	3061	31	4967	33
1137	3	1603	12	1755	17	1922	22	1944G	26	3063	31	4972	33
1138	3	1605	12	1756	17	1922 L	22	1945G	26	3065	31	4975	33
1150	4	1607	12	1759	18	1923	22	1947G	26	3084	31	4975.02	33
1152	4	1608	12	1760	18	1925	22	1948G	26	3100	31	4980	33
1155	4	1612	12	1760.04	18	1927	22	1951G	26	3118	31	4999	33
1159	6	1620	13	1763	18	1928	22	1952G	26	3124	31	5150	34
1160	6	1621	13	1767	18	1932	22	1955G	26	3136	31	5219	34
1161	6	1622	13	1774	18	1935	22	1969G	27	3218	31	5220	34
1162	6	1622L	13	1780	18	1937	22	1972G	27	3224	31	5220.03	34
1163	6	1623	13	1785	18	1938	22	1973G	27	3238	31	5221	34
1171	5	1623D	13	1787	18	1940	23	1976G	27	3244	31	5222	34
1172	5	1625	13	1789	18	1941	23	1977G	27	3548	32	5223	34
1226	5	1626	13	1791	18	1941 H	23	1985G	27	3550	32	5224	34
1231	5	1627	13	1793	18	1941.02	23	1987G	27	3552	32	5224.02	34
1235	5	1632	13	1794	18	1941.05	23	1999G	27	3554	32	5224.03	34
1291	5	1635	13	1795	18	1941H.05	23	2400	28	3574	32	5226	34
1292	5	1660	14	1730 G	19	1942	23	2401	28	3576	32	5227	34
1301	9	1661	14	1735 G	19	1942 B	27	2402	28	3578	32	5228	34
1330	9	1662	14	1740 G	19	1942 B-CP	27	2403	28	3580	32	5230	34
1335	9	1663	14	1743 G	19	1942 F	23	2405	28	3590	32	5243	35
1340	9	1663 D	14	1745 G	19	1943	23	2407	28	3592	32	5244	35
1342		1665	14	1750 G	19	1943.05	23	2412	28	3594	32	5280	35
1343	9	1667	14	1755 G	19	1944	23	2418	28	3596	32	5283	35
1345	9	1671	14	1756 G	19	1945	23	2420	29	3597	32	5284	35
1350	9	1673	14	1760 G	19	1947	24	2421	29	3598	32	5285	35
1355	9	1675	15	1787 G	19	1948	24	2422	29	3612	32	5292	35
1360	9	1678	15	1789 G	19	1951	24	2423	29	3618	32	5293	35

Art/Part Number	Page No.	Art/Part Number	Page No.	Art/Part Number	Page No.	Art/Part Number	Page No.	Art/Part Number	Page No.	Art/Part Number	Page No.	Art/Part Number	Page No.
5295	35	5838	37	7204	41	8138	43	8694	44	9505.07	49	10903	55
5296	35	5844	37	7206	41	8139	43	8695	44	9507	49	10910	55
5303	35	5846	38	7214	41	8140	43	8701	47	9508	49	10921	55
5313	35	5858	38	7216	41	8141	43	8702	47	9511	50	10925	55
5313.04	67	5859	38	7280	41	8201	43	8703	47	9513	50	10930	55
5313.05	67	5862	38	7286	41	8214	43	8704	47	9515	50	10938	55
5323	35	5863	38	7287	41	8216	43	8706	47	9521	50	10945	55
5333	35	5868	38	7288	41	8234	43	8762	47	9523	50	11001	56
5333.04	67	5869	38	7289	41	8236	43	8763	47	9525	50	11003	56
5333.05	67	5874	38	7290	41	8401	43	8764	47	9551	50	11005	56
5345	35	5875	38	7354	41	8414	43	8766	47	9601	50	11007	56
5348	35	5889	38	7356	41	8416	43	8781	47	9601.1	50	11009	56
5355	35	5892	38	7364	41	8434	43	8782	47	9609	50	11010	56
5358	35	5892.01	38	7366	41	8436	43	8783	47	9609.03	50	11015	56
5365	35	5896	38	7380	41	8440	44	8784	47	9609.04	50	11016	56
5365.02	67	5896.01	38	7384	42	8475	46	8785	47	9609.05	50	11025	56
5365.03	67	5896.08	38	7385	42	8476	44	8805	47	9609.06	50	11060	56
5370	35	5897	38	7386	42	8477	44	8810	47	9609.07	50	11084	56
5380	35	5898	38	7387	42	8478	44	8813	47	9615	50	11090	56
5385	35	5915	38	7388	42	8479	44	8815	48	9618	50	11092	56
5385.02	35	5920	38	7480	42	8480	44	8875	48	9951	50	11105	56
5385.04	35	5960	38	7480.01.01	42	8484	44	8884	48	9961	50	11515	57
5550	36	6202	39	7484	42	8485	44	8886	48	9991	51	11611	58
5565	36	6203	39	7486	42	8486	44	8888	48	9995	51	11611.5	58
5575	36	6212	39	7494	42	8487	44	8890	48	10301	51	11612	58
5575.02.03		6232	39	7496	42	8488	44	8891	48	10305	51	11613	58
5575.05	36	6233	39	7501	42	8490	44	8892	48	10610	51	11615	58
5585	36	6242	39	7504	42	8505	45	8894	48	10611	51	11616	58
5765	36	6320	39	7506	42	8520	45	8898	48	10615	52	11617	58
5776	36	6330	39	7514	42	8520.51	45	8899	48	10625	52	11621	58
5790	37	6340	39	7516	42	8531	45	8900	48	10705	53	11623	58
5792	37	6350	39	7540	42	8541	45	8902	48	10710	53	11625	58
5795	37	6353	39	7541	42	8545	45	8903	48	10715	53	11650	58
5795A	37	6355	40	7543	42	8548	45	8904	48	10720	53	11651	58
5796	37	6363	40	7548	42	8570	46	9490	49	10721	53	11750	59
5796 A	37	6364	40	7550	42	8600	46	9490.02	49	10721.51	53	11800	59
5797	37	6365	40	7600	42	8601	46	9490.03	49	10724	53	11812	59
5797 A	37	7004	40	7601	42	8601A	46	9490.04	49	10724.04	53	11832	59
5798	37	7004.08	40	7602	42	8601a.51	46	9490.05	49	10727	53	11834	59
5798 A	37	7006	40	7603	42	8602	46	9490.06	49	10730	53	11851	60
5799	37	7008	40	7604	42	8604	46	9490.1	49	10738	54	11852	60
5799 A	37	7010	40	8014	43	8615	46	9491	49	10739	54	11855	60
5802	37	7010.08	40	8016	43	8616	46	9495	49	10740	54	11871	59
5803	37	7011	40	8018	43	8617	46	9498	49	10741	54	11872	59
5809	37	7014	40	8024	43	8630	46	9501	49	10742	54	11898	59
5812	37	7014.07	40	8026	43	8632	46	9501.02	49	10745	54	11899	59
5812.02	37	7016	40	8030	43	8685	44	9502	49	10750	54	12105	59
5812.07	37	7018	40	8032	43	8686	44	9505	49	10870	54	12106	59
5812.08	37	7175	41	8034	43	8687	44	9505.03	49	10880	54	12205	60
5818	37	7182	41	8036	43	8688	44	9505.04	49	10888	54	12208	60
5824	37	7201	41	8038	43	8692	44	9505.05	49	10900	55	12512	60
5832	37	7202	41	8137	43	8693	44	9505.06	49	10901	55	12514	60

Art/Part Number	Page No.	Art/Part Number	Page No.	Art/Part Number	Page No.	Art/Part Number	Page No.	Art/Part Number	Page No.	Art/Part Number	Page No.	Art/Part Number	Page No.
12534	60	14103.51	67	18520	68	23114	70	25510	73	39250	74	40902	80
12536	60	14104.51	67	18580	68	23115	70	25514	73	39251	74	40903	80
12550	60	14106.51	67	18582	68	23231	70	25515	73	39260	75	40904	80
12572	62	14102	67	18584	68	23232	70	25602	73	39262	75	40905A	74
12573	62	14103	67	18586	68	23234	70	25604	73	39265	75	40905B	74
12574	62	14104	67	18588	68	23242	70	25608	73	39268	75	40905 F	74
12575	62	14105	67	18590	68	23802	70	25611	73	39335	74	40905 H	75
12578	62	14106	67	18703	68	23804	70	25613	73	39336	74	40906 A	74
12635	62	14209	67	18713	68	23808	70	25622	73	39340	74	40906 B	74
12640	62	14219	67	19800	68	23812	70	25624	73	39341	74	40906 F	74
12642	62	14229	67	22002	69	23822	71	25702	73	39350	74	40906 H	75
12643	62	14232	67	22006	69	23824	71	25703	73	39351	74	40907	80
12644	62	14240	67	22007	69	23902	71	25705	73	39400	76	40913	74
12703	63	14241	67	22011	69	23903	71	25802	73	39405	76	40914	74
12705	63	14242	67	22011 A	69	23905	71	25803	73	39415	76	40915A	74
12708	63	14243	67	22012	69	23907	71	25805	73	39420	76	40915 B	74
12712	63	15101	67	22012 A	69	23909	71	25808	73	39550 A	77	40915 F	75
12722	63	15102	67	22013	69	24102	71	25809	73	39550 B	77	40915 H	75
12730	63	15103	67	22013 A	69	24103	71	25811	73	39550 C	77	40916A	74
12775	64	15104	67	22014	69	24104	71	25817	73	39550 D	77	40916 B	74
12885	64	15105	67	22014 A	69	24105	71	25903	73	39588	75	40916 F	74
12902	64	15106	67	22015	69	24106	71	25904	73	39590	75	40916 H	75
12912	64	15107	67	22015 L	69	24108	71	25905	73	39594	75	40920	74
12914	64	15112	67	22016	69	24109	71	25906	73	39594 G	75	40920 B	74
12917	64	16110	68	22018	69	24129	71	25907	73	39595	76	40921	74
12920	64	16112	68	22021	69	24132	71	25908	73	39604	78	40921 B	74
12921	64	16114	68	22024	69	24134	71	25909	73	39604 G	78	40925	75
12930	64	18302	68	22114	69	24202	71	25917	73	39605	78	41003	80
12932	64	18303	68	22135	69	24205	71	26105	73	39607	78	41004	80
13721	65	18304	68	22170	69	24207	71	26106	73	39610	78	41005	80
13722	65	18305	68	22185	69	24208	71	27705	73	39611	78	41015	80
13742	65	18306	68	22302	69	24209	71	27706	73	39613	78	41020	80
13744	65	18310	68	22303	69	24210	71	27707	73	39620	79	41021	80
13745	65	18312	68	22304	69	24211	71	27708	73	39621	79	41103	81
13747	65	18314	68	22306	69	24402	71	27709	73	39623	79	41105	81
13760	65	18316	68	22309	69	24403	71	27717	73	39628	79	41115	81
13765	65	18318	68	22312	69	24405	71	28007	73	39629	79	41302	81
13775	65	18320	68	22318	69	24502	72	28009	73	39631	79	41313	81
13785	65	18424	68	22324	69	24503	72	28205	73	39635	79	41324	81
13788	65	18425	68	22330	69	24802	72	28206	73	39636	79	41325	81
14026	66	18426	68	22336	69	24803	72	28505	73	39638	79	41335	81
14027	66	18427	68	22348	69	24902	72	28506	73	39695	76	41336	81
14028	66	18428	68	22353	69	24903	72	28509	73	39700	76	41505	81
14029	66	18429	68	22354	69	24922	72	38880	15	39700.02	76	41515	81
14101	67	18501	68	22356	69	24923	72	39215	74	39720	76	41517	81
14101.06	67	18502	68	22359	69	24932	72	39216	74	39720.02	76	41519	81
14101.12	67	18503	68	22365	69	24950	72	39220	74	39735	76	41526	81
14101.51	67	18510	68	22367	69	24952	72	39221	74	40865	80	41536	81
14102.06	67	18512	68	22369	69	24955	72	39238	74	40890	80	41540	81
14102.07	67	18514	68	23105	70	24957	72	39240	74	40891	80	41541	81
14103.07	67	18516	68	23106	70	25505	73	39242	74	40892	80	41588	81
14103.12	67	18518	68	23110	70	25506	73	39245	74	40893	80	41705	81

Art/Part Number	Page No.	Art/Part Number	Page No.	Art/Part Number	Page No.	Art/Part Number	Page No.
41715	81	44695	84	47415	88	56762	7
41718	81	44698	84	47420	88	56765	7
41719	81	44705	84	47422	88	56768	7
41726	81	44710	84	47425	88	56772	7
41736	81	44715	84	47426	88	56775	7
41810	81	44786	84	48505	88	58021	90
41811	81	44790	84	48505.03	88	58024	90
41816	81	44791	84	48515	88	58131	90
41818	81	44792	84	48516	88	58135	90
42001	82	44793	84	48517	88	58142	90
42001.02	82	44794	84	48518	88	62000	91
42001 G	82	44795	84	48519	88	62245	91
42001G.02	82	44970	85	48526	88	62250	91
42002	82	44972	85	48536	88	66950 F	91
42002.02	82	44980	85	48540	88	66950 M	91
42004	82	44985	85	48542	88	66950 MF	91
42014	82	44990	85	48545	88	79880	91
42025	82	45093	86	48546	88	79900	91
42035	82	45095	86	53600	89	80100	91
44550	83	45096	86	53605	89	80105	91
44552	83	45097	86	53800	89	80108	91
44554	83	45098	86	53850	89	80110	91
44556	83	45100	86	53900	89	80140	92
44562	83	45101	86	54000	89	80150	92
44564	83	45103	86	54909	4	80160	92
44566	83	45104	86	56331	90	80170	92
44568	83	45105	86	56333	90	80180	92
44650	83	45109	86	56334	90	80190	92
44652	83	45110	86	56350	90	80200	92
44652.01	83	45111	86	56420	6	88900	4
44653	83	45112	86	56422	6	88910	4
44655	83	45115	86	56426	6	88918	4
44656	83	45116	86	56428	6		
44658	83	45128	86	56430	6		
44659	83	45130	86	56432	6		
44668	84	45132	86	56600	6		
44673	84	45140	86	56602	6		
44675	84	45145	86	56604	6		
44678	84	45200	86	56606	6		
44679	84	45203	86	56630	6		
44681	84	45205	87	56630.01.03	6		
44682	84	45215	87	56631	6		
44686	84	45218	87	56650	7		
44688	84	45225	87	56652	7		
44689	84	45226	87	56695	7		
44690	84	45250	87	56697	7		
44690.03	84	45255	87	56740	7		
44690 D	84	45275	87	56744	7		
44691	84	45280	87	56747	7		
44692	84	46305	88	56752	7		
44693	84	46315	88	56755	7		
44694	84	47405	88	56757	7		



AIM Tech

📍 Pathankot Road, Near Reru Pind Gate, Jalandhar - 144012 (Punjab) India

☎ +91-181-5074100, 2604100, 2604200

✉ viking@vikingindia.com 🌐 www.vikingindia.com